

### Component Image & Dimension

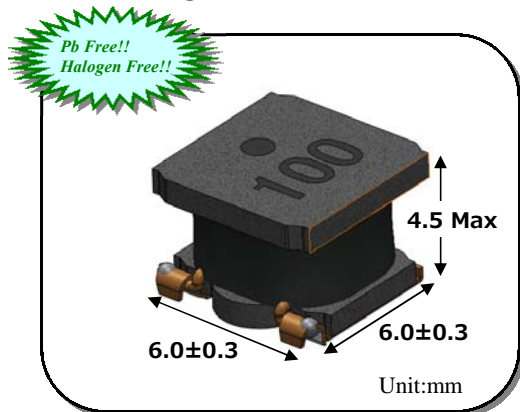

### Features :

- Miniature Size :  
Mount Area : 6.0mm x 6.0mm  
4.5mm Max. Height
- Generic use for DC/DC Converter Line.
- Automatic Mounting in Tape & Reel Package.

### Recommended Land Pattern

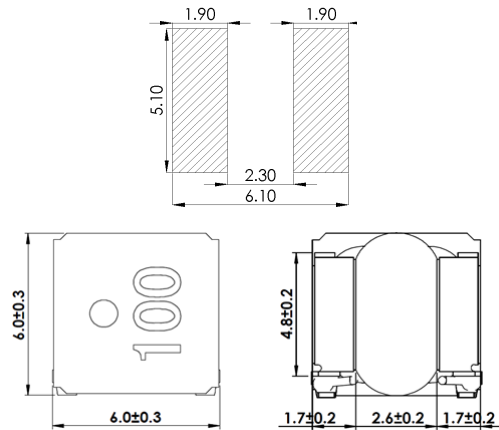

### Applications :

DC-DC Converter for Note-PC, Monitor etc.

### Electrical Specification

TDK Identification	Inductance (uH)	Tol. (%)	Test Freq. (kHz)	DC Resistance		Rated DC Current	
				Typ. (Ohm)	Tol. (%)	* Idc 1 (A max.)	* Idc 2 (A typ.) ④⑤⑥⑦⑧
VLS6045EX- R47N	0.47	+/-30%	100	0.010	+/-30%	13.5	7.0
VLS6045EX- 1R0N	1.0	+/-30%	100	0.012	+/-30%	12.0	6.0
VLS6045EX- 1R2N	1.2	+/-30%	100	0.014	+/-30%	10.0	5.4
VLS6045EX- 1R5N	1.5	+/-30%	100	0.017	+/-30%	8.2	5.3
VLS6045EX- 2R0N	2.0	+/-30%	100	0.018	+/-30%	8.0	5.2
VLS6045EX- 2R2N	2.2	+/-30%	100	0.019	+/-30%	7.5	5.1
VLS6045EX- 3R0N	3.0	+/-30%	100	0.022	+/-30%	6.9	5.0
VLS6045EX- 3R3N	3.3	+/-30%	100	0.023	+/-30%	6.5	4.95
VLS6045EX- 3R6N	3.6	+/-30%	100	0.024	+/-30%	6.2	4.9
VLS6045EX- 4R7M	4.7	+/-20%	100	0.027	+/-30%	5.8	4.2
VLS6045EX- 6R8M	6.8	+/-20%	100	0.036	+/-30%	4.7	3.6
VLS6045EX- 100M	10	+/-20%	100	0.047	+/-30%	3.9	3.4
VLS6045EX- 150M	15	+/-20%	100	0.075	+/-30%	3.1	2.5
VLS6045EX- 220M	22	+/-20%	100	0.105	+/-30%	2.4	1.9
VLS6045EX- 330M	33	+/-20%	100	0.175	+/-30%	1.9	1.5
VLS6045EX- 470M	47	+/-20%	100	0.23	+/-30%	1.8	1.3
VLS6045EX- 680M	68	+/-20%	100	0.31	+/-30%	1.4	1.0
VLS6045EX- 101M	100	+/-20%	100	0.47	+/-30%	1.1	0.9
VLS6045EX- 151M	150	+/-20%	100	0.76	+/-30%	0.9	0.7
VLS6045EX- 221M	220	+/-20%	100	1.15	+/-30%	0.8	0.5

Note)

\* Idc1 : Depend on inductance change (-30% reduction from initial value)

\* Idc2 : Depend on self temperature rise (40degC typical)

Operating Temperature Range : -40deg.C ~ +105deg.C(Including Self Temp.Rise)

# VLS6045EX Type

## Idc1: Inductance vs. DC Superposition Characteristics(Ref)

## Idc2: Temp.Rise(Ref)

TDK' PartNo.:VLS6045EX-R47N

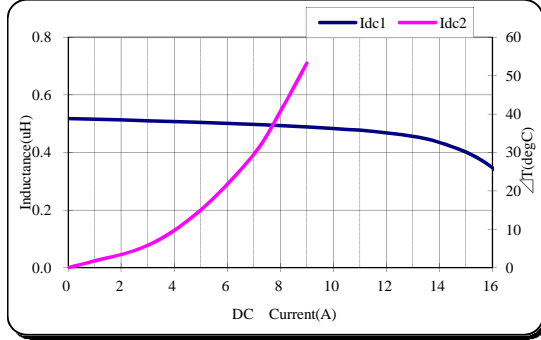

TDK' PartNo.:VLS6045EX-1R0N

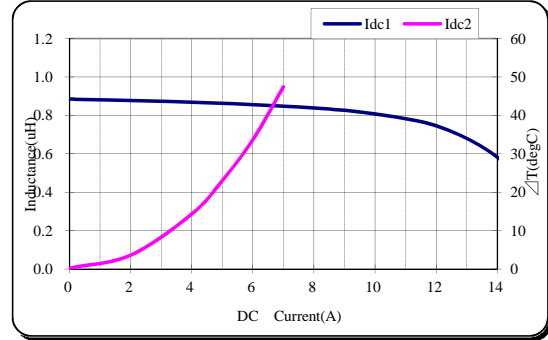

TDK' PartNo.:VLS6045EX-1R2N

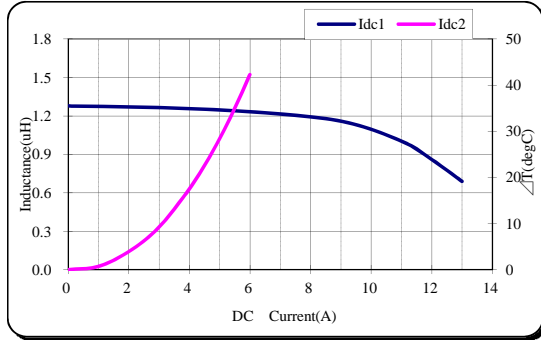

TDK' PartNo.:VLS6045EX-1R5N

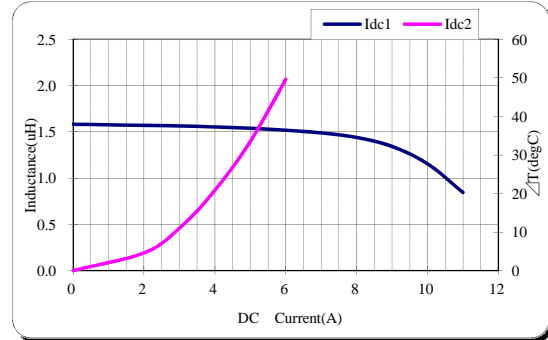

TDK' PartNo.:VLS6045EX-2R0N

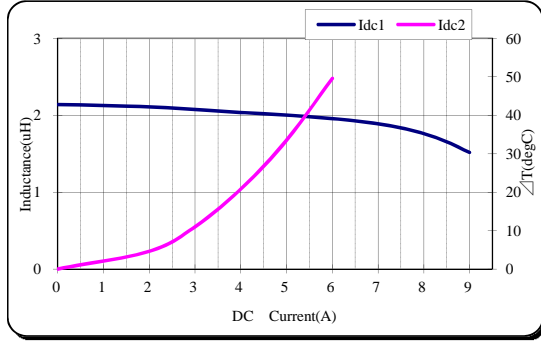

TDK' PartNo.:VLS6045EX-2R2N

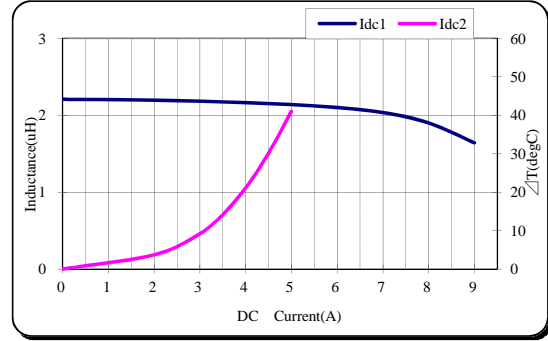

TDK' PartNo.:VLS6045EX-3R0N

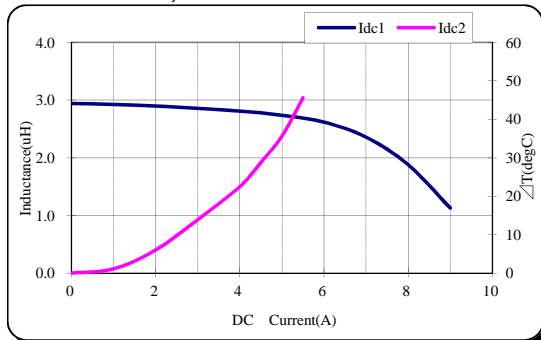

TDK' PartNo.:VLS6045EX-3R3N

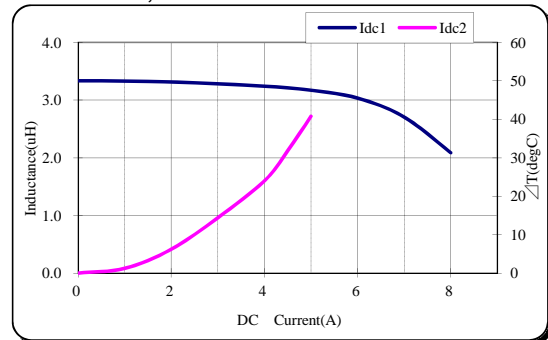

TDK' PartNo.:VLS6045EX-3R6N

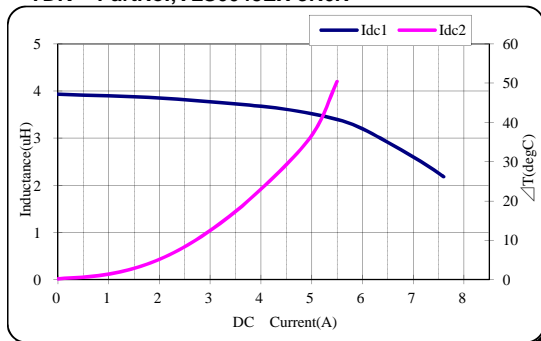

TDK' PartNo.:VLS6045EX-4R7M

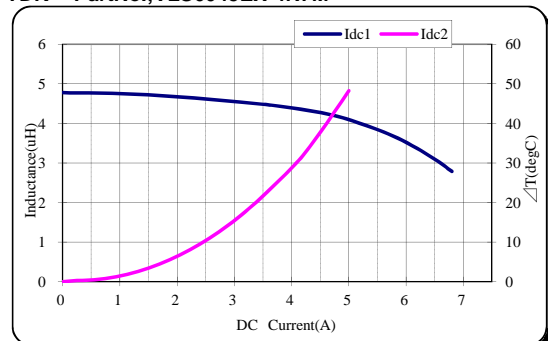

TDK' PartNo.;VLS6045EX-6R8M

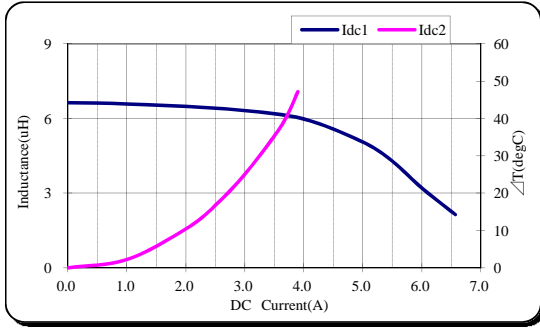

TDK' PartNo.;VLS6045EX-100M

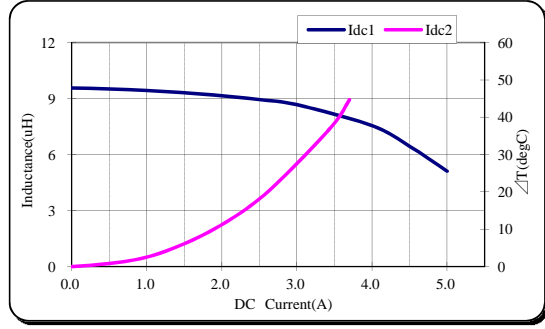

TDK' PartNo.;VLS6045EX-150M

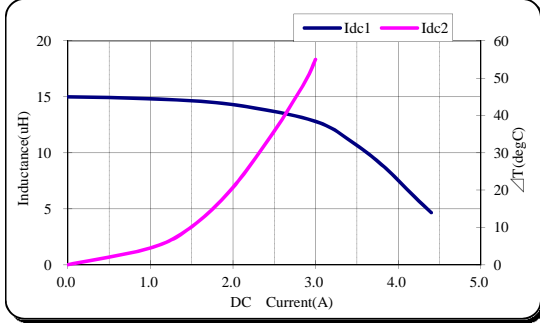

TDK' PartNo.;VLS6045EX-220M

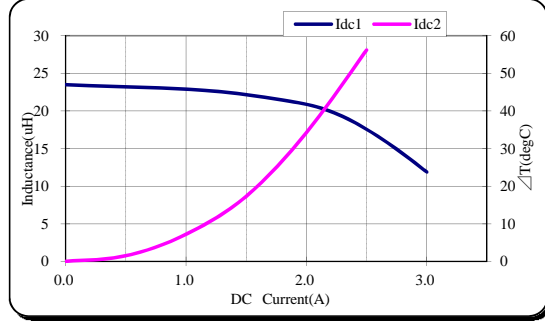

TDK' PartNo.;VLS6045EX-330M

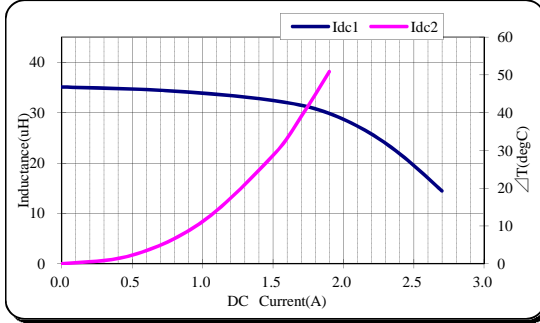

TDK' PartNo.;VLS6045EX-470M

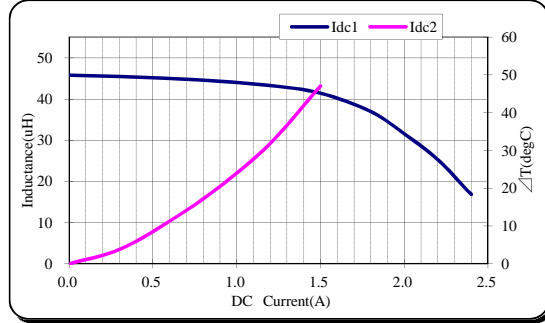

TDK' PartNo.;VLS6045EX-680M

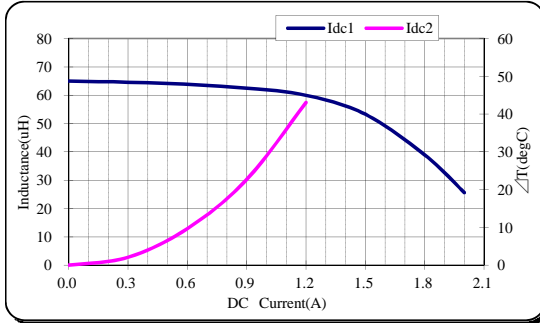

TDK' PartNo.;VLS6045EX-101M

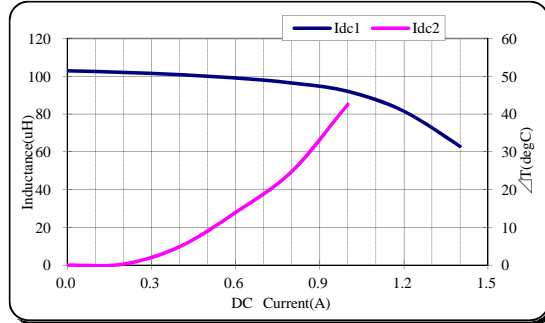

TDK' PartNo.;VLS6045EX-151M

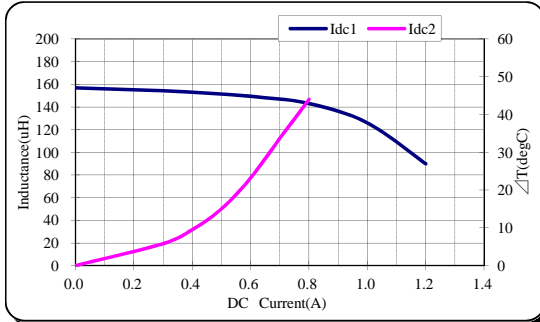

TDK' PartNo.;VLS6045EX-221M

