



**Power Factor Correction
Boundary Current Mode Method
200 W 400 V
BD7692FJ Reference Board**

User's Guide

<High Voltage Safety Precautions>

◇ Read all safety precautions before use

Please note that this document covers only the BD7692FJ evaluation board (BD7692FJ-EVK-001) and its functions. For additional information, please refer to the datasheet.

To ensure safe operation, please carefully read all precautions before handling the evaluation board



Depending on the configuration of the board and voltages used,

Potentially lethal voltages may be generated.

Therefore, please make sure to read and observe all safety precautions described in the red box below.

Before Use

- [1] Verify that the parts/components are not damaged or missing (i.e. due to the drops).
- [2] Check that there are no conductive foreign objects on the board.
- [3] Be careful when performing soldering on the module and/or evaluation board to ensure that solder splash does not occur.
- [4] Check that there is no condensation or water droplets on the circuit board.

During Use

- [5] Be careful to not allow conductive objects to come into contact with the board.
- [6] **Brief accidental contact or even bringing your hand close to the board may result in discharge and lead to severe injury or death.**

Therefore, DO NOT touch the board with your bare hands or bring them too close to the board.

In addition, as mentioned above please exercise extreme caution when using conductive tools such as tweezers and screwdrivers.

- [7] If used under conditions beyond its rated voltage, it may cause defects such as short-circuit or, depending on the circumstances, explosion or other permanent damages.
- [8] Be sure to wear insulated gloves when handling is required during operation.

After Use

- [9] The ROHM Evaluation Board contains the circuits which store the high voltage. Since it stores the charges even after the connected power circuits are cut, please discharge the electricity after using it, and please deal with it after confirming such electric discharge.
- [10] Protect against electric shocks by wearing insulated gloves when handling.

This evaluation board is intended for use only in research and development facilities and should be handled **only by qualified personnel familiar with all safety and operating procedures.**

We recommend carrying out operation in a safe environment that includes the use of high voltage signage at all entrances, safety interlocks, and protective glasses.

PFC (power Factor Correction) IC

PFC BCM (Boundary Current Mode) Method Output 200 W 400 V BD7692FJ Reference Board

BD7692FJ-EVK-001

The BD7692FJ-EVK-001 reference board outputs 400 V voltage from the input of 90 Vac to 264 Vac. The output current supplies up to 0.5 A. The BD7692FJ which is BCM method PFC controller IC is used.

The BD7692FJ supplies the system which is suitable for all of products that requires PFC.

BCM is used for PFC part, and Zero Current Detection reduces both switching loss and noise. An auxiliary winding wire is not required because of ZCD by a resistor.

Electronics Characteristics

Not guarantee the characteristics, is representative value.

Unless otherwise noted; $V_{IN} = 230 \text{ Vac}$, $I_{OUT} = 0.5 \text{ A}$, $T_a = 25 \text{ }^\circ\text{C}$

Parameter		Min	Typ	Max	Units	Conditions
Input Voltage Range	V_{IN}	90	230	264	Vac	
Input Frequency	f_{LINE}	47	50/60	63	Hz	
Output Voltage	V_{OUT}	384	400	416	V	
Maximam Output Power	P_{OUT}	-	-	200	W	$I_{OUT} = 0.5 \text{ A}$
Output Current Range ^(Note 1)	I_{OUT}	0.0	-	0.5	A	
PF(Power Factor)	PF	0.93	0.97	-	-	AC230 V $I_{OUT} = 0.5 \text{ A}$
Efficiency	η	94	96.	-	%	
Output Ripple Voltage ^(Note 2)	V_R	-	14	20	Vpp	
Hold Time	T_{HOLD}	20			ms	$V_{OUT} \text{ min } 280 \text{ V}$
Operating Temperature Range	T_{OP}	-10	+25	+65	$^\circ\text{C}$	

(Note 1) Please adjust operating time to keep any parts surface temperature under 105 $^\circ\text{C}$

(Note 2) Not include spike noise

Operation Procedure

1. Operation Equipment

- (1) AC power supply 90 ~ 264 Vac, over 200 W
- (2) Electronic load capacity 0.5 A which supports input voltage 500 V
- (3) Multi meter
- (4) Power meter
- (5) DC power supply +15 V

2. Connect Method

- (1) AC power supply presetting range 90 ~ 264 Vac, Output switch is OFF.
- (2) Electronic load setting under 0.5 A, Load switch is OFF.
- (3) The reference board connects to measuring equipments and power supplies as in Fig. 1.
- (4) AC power supply switch is ON.
- (5) DC power supply (+15 V) switch is ON.
- (6) Check that output voltage is 400 V.
- (7) Electronic load switch is ON.
- (8) Operate with enough caution against electric shock because of non-isolated output voltage 400 V.

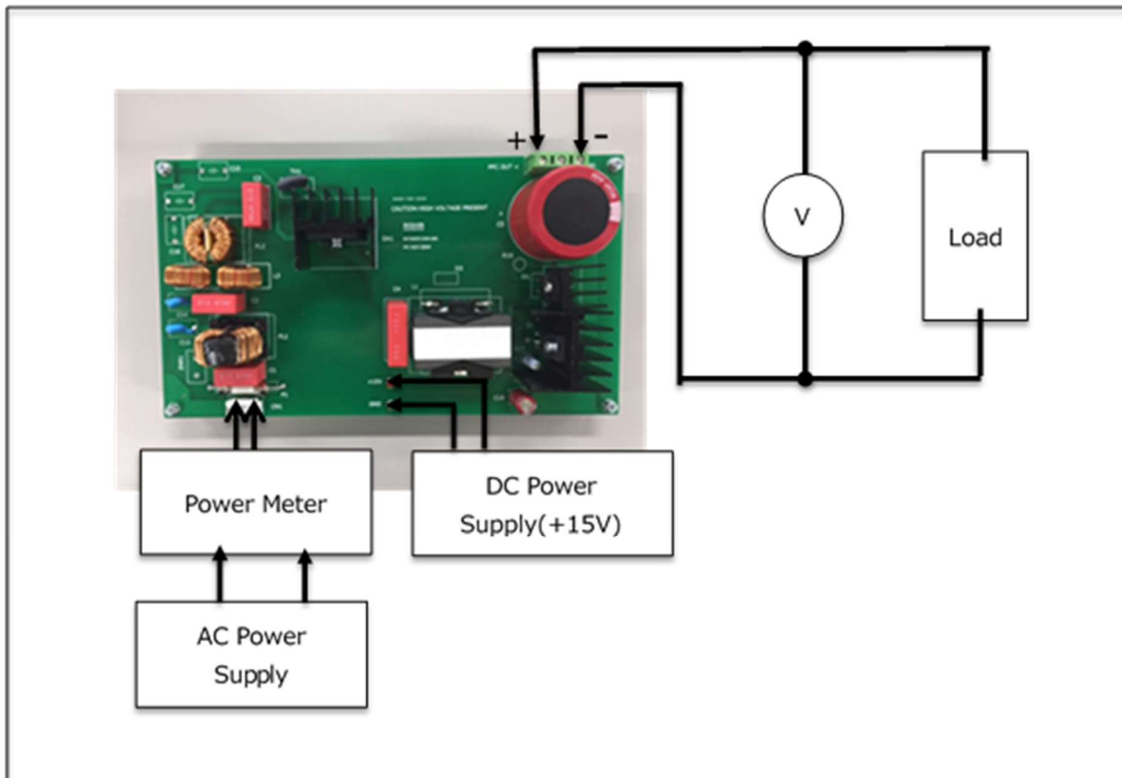

Figure 1. Connection Circuit

Derating

Maximum output power P_o of the reference board is 200 W. The derating curve is shown in Fig. 2.

If ambient temperature is over 40 °C, please adjust load continuous time to keep any parts surface temperature under 105 °C.

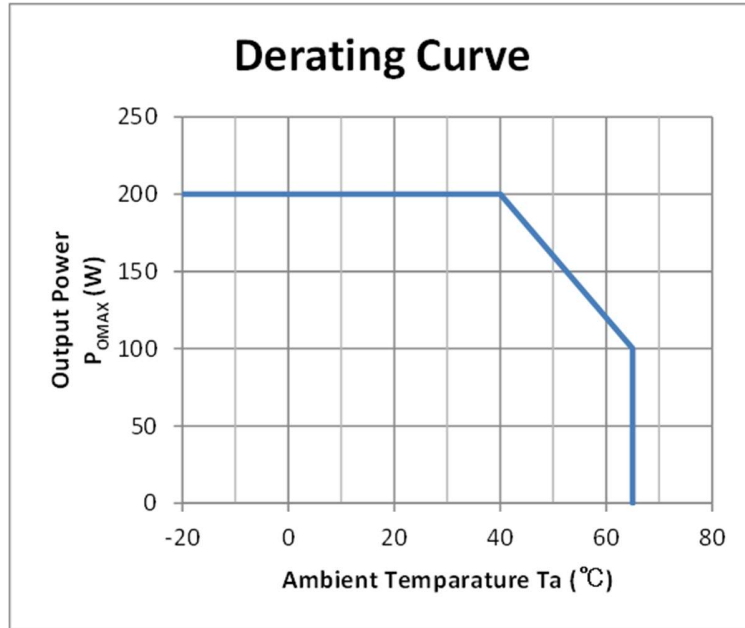

Figure 2. Temperature derating curve

Schematics

$V_{IN} = 90 \sim 264 \text{ Vac}$, $V_{OUT} = 400 \text{ V}$

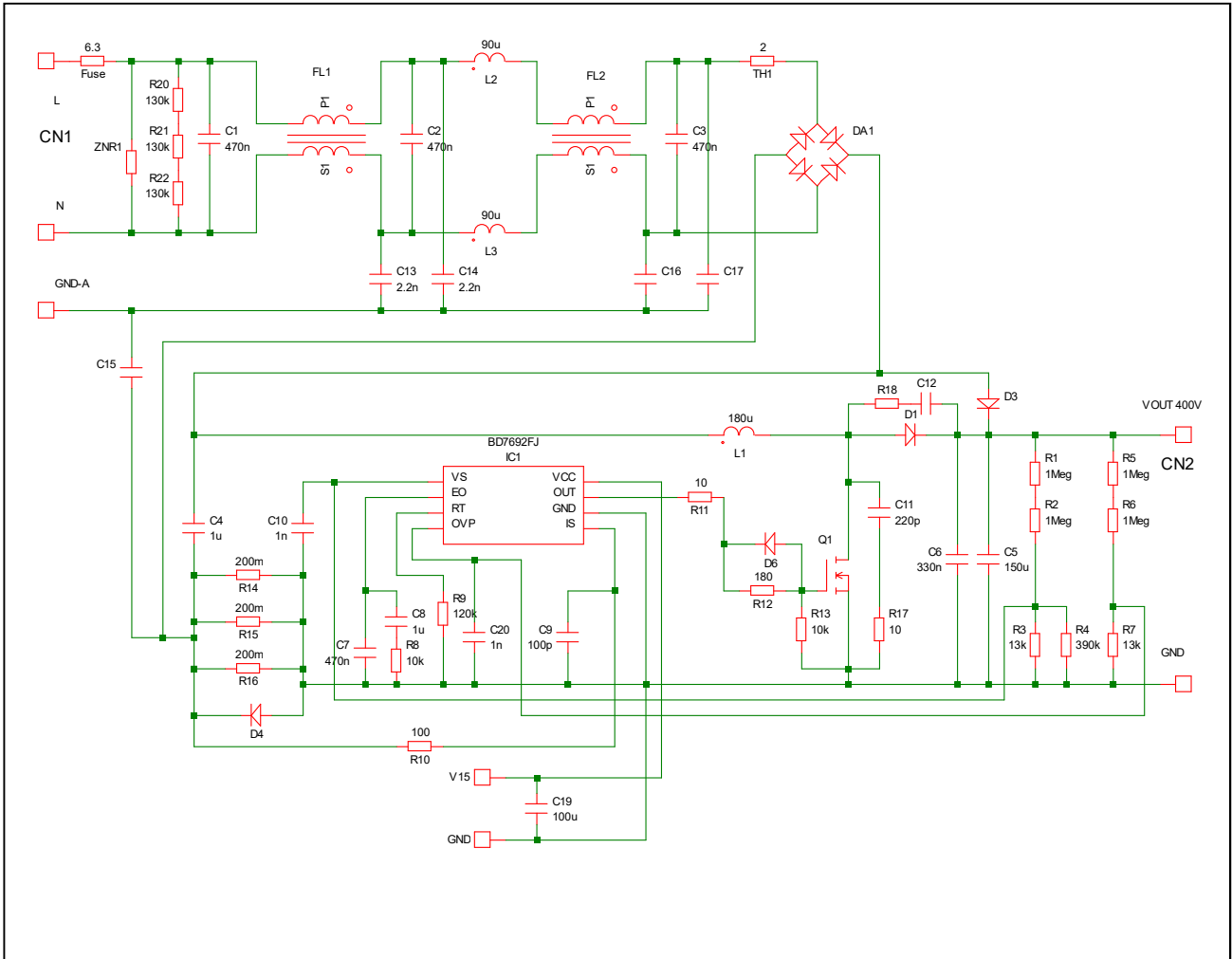

Figure 3. BD7692FJ-EVK-001 Schematics

Bill of Materials

Table 1. BoM of BD7692FJ-EVK-001

	Item	Spec	Parts name	Manufacture
Capacitor	C1,C2,C3	0.47 uF / 310 V	890 334 025 039 CS	WURTH
	C4	1 uF / 400 Vdc	890 283 326 009 CS	WURTH
	C5	150 uF / 450 V	861 021 486 027	WURTH
	C6	0.33 uF / 500 V	GRM55DR72H334KW10	MURATA
	C7	0.47 uF / 6.3 V	JMK107B7474KA-T	Taiyo Yuden
	C8	1 uF / 25 V	TMK107B7105KA-T	Taiyo Yuden
	C9	100 pF / 100 V	HMK107SD101KA-T	Taiyo Yuden
	C10,C20	1000 pF / 100 V	HMK107B7102MA-T	Taiyo Yuden
	C11	220 pF / 2 kV	885342209008	WURTH
	C12	-	-	-
	C13,C14	2200 pF / 250 V	DE1E3RA222MJ4BQ01F	Murata
	C15,C16,C17	-	-	-
C19	100 uF / 50 V	860 080 674 009	WURTH	
Diode	D1	FRD 600 V / 20 A	RFS20TJ6S	Rohm
	D4	600 V / 2 A	RR2LAM6S	Rohm
	D3	-	-	-
	D6	FRD 200 V / 0.5 A	RF05VAM2STR	Rohm
MOSFET	Q1	600 V / 24 A	R6024KNX	Rohm
Diode-Bridge	DA1	600 V / 15 A	GBU15J-U1	Willas Corp
Resistor	R1,R2,R5,R6	1Meg	KTR18PZPF1004	Rohm
	R3, R7	13k	MCR03PZPZFX1302	Rohm
	R4	390k	MCR03PZPZFX3903	Rohm
	R8	10k	MCR03EZPJ103	Rohm
	R9	120k	MCR03PZPZJ124	Rohm
	R10	100	MCR18PZPZJ101	Rohm
	R11	10	MCR18EZPJ100	Rohm
	R12	180	MCR18EZPJ181	Rohm
	R13	10k	MCR18ZPZJ103	Rohm
	R14, R15,R16	0.2 / 1 W	LTR18PZPFLR200	Rohm
	R17	10 / 2 W	ERG2SJ100V	Panasonic
	R18	-	-	-
	R20, R21,R22	130k	MCR18PZPZJ134	Rohm
OTHER	Fuse	250 Vac 6.3 A	VBS UDA-A6.30A	Tan doe Corp
	IC1	PFC	BD7692FJ	Rohm
	FL1	35 mH / 3.5 A	7448040435	WURTH
	FL2	15 mH / 6 A	GSTC1810-153N	Gang Song
	TH1	2 Ω / 4 A	2D2-13LD	SEMITEC
	L1	180 uH / 8.8 A	PFC3819QM-181K09B-50	TDK
	L2, L3	90 uH / 4.6 A	744 701 3	WURTH
	HEAT1,HEAT3	11.5 K/W	30PBE30-30B	Marusan
	HEAT2	22.9 K/W	IC-1625-STL	Sankyo Thremotec
	PCB	-	-	-
	CN1	3pin	B03P-NV(LF)(SN)	JST
	CN2	3pin	691137910003	WURTH

Materials may be changed without notifying.

PCB

Size: 200 mm x 112 mm

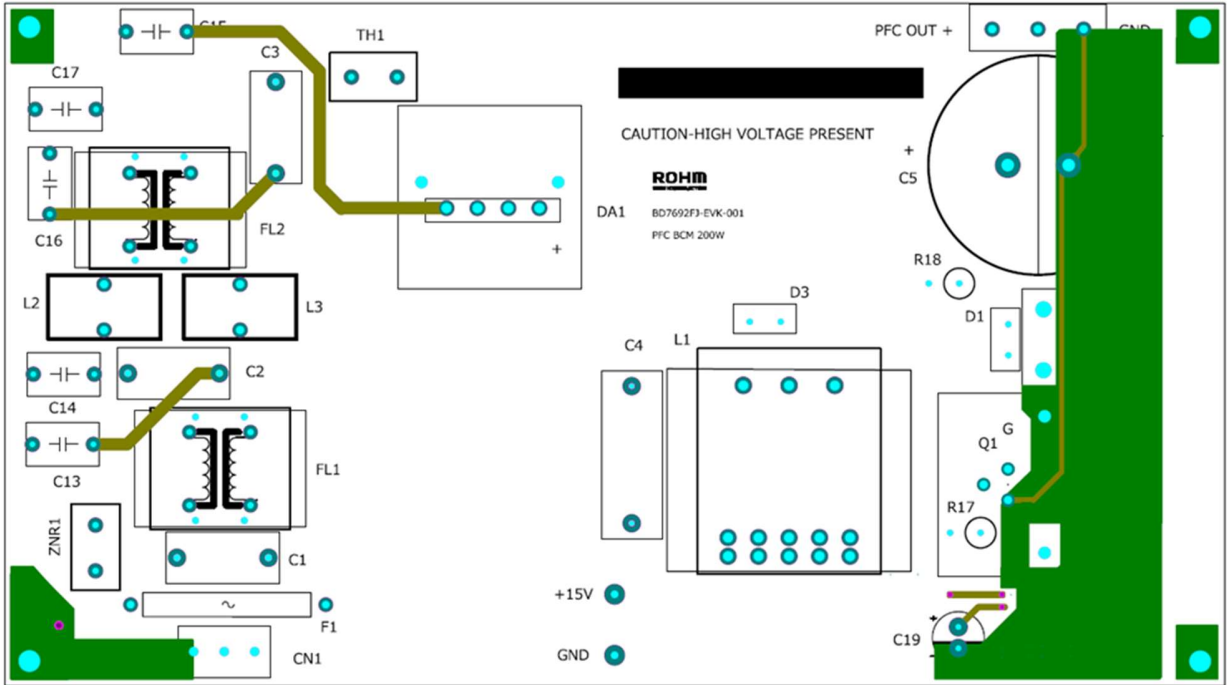

Figure 4. Top Silkscreen (Top view)

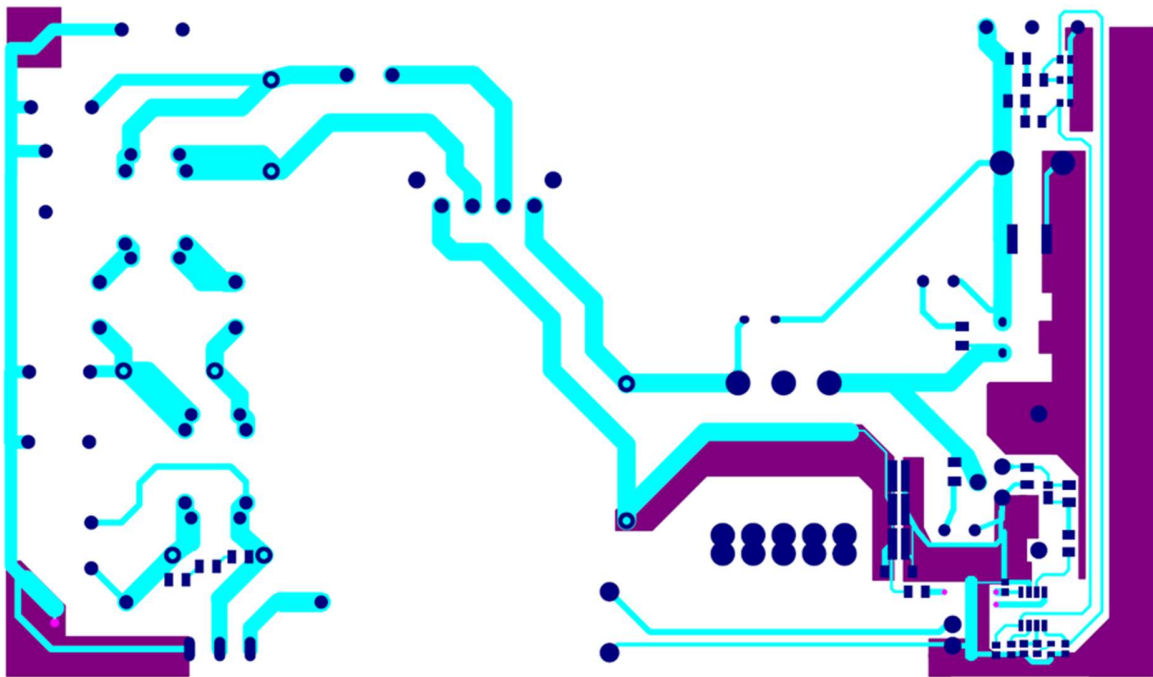

Figure 5. Bottom Layout (Top view)

BD7692FJ Overview

Feature

- Boundary Current Mode
- Low Power Consumption
- Under Voltage Lock Out at VCC
- Zero Current Detection by a resistor
- Reduction of both Switching Loss and Noise by ZCD
- Dynamic&Static Over Voltage Protection at VS
- High Precision Over-current Detection (±4%)
- Error Amplifier Input Short Protection
- Stable MOSFET Gate Driving by Built-in Clamper
- Over Voltage Protection
- Soft Start Function
- IS-GND Short Timer Operation

Key Specification

- Operating Power Supply Voltage Range : 10.0 V ~ 26.0 V
- Circuit Current : 470 μA (Typ.)
- Maximum Frequency : 450 kHz (R_{RT}120 kΩ)
- Operating Temperature Range : -40 °C ~ +105 °C

Dimension W(Typ) x D(Typ) x H(Max)
 SOP-J8 4.90 mm x 6.00 mm x 1.65 mm
 Pitch 1.27 mm

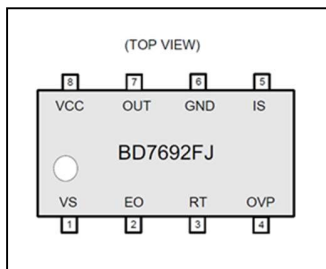

Figure 6. Block Diagram

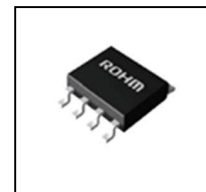

Figure 7. SOP-J8 Package

Table 2. BD7692FJ PIN description

No.	Name	I/O	Function	ESD Diode	
				VCC	GND
1	VS	I	Feedback input	-	○
2	EO	I/O	Error amp output	-	○
3	RT	I/O	Maximum frequency setting	-	○
4	OVP	I	Over voltage protection	-	○
5	IS	I	Zero current and over current detection	-	○
6	GND	-	GND	○	-
7	OUT	O	External MOSFET gate control	-	○
8	VCC	I	VCC	-	○

Design Overview

1 Key Parameter

- V_{IN} : Input Voltage Range AC 90 V ~ 264 Vac
- V_{OUT} : Output Voltage DC 400 V \pm 16 V
- $I_{OUT(Max)}$: Maximum Output Current 0.5 A
- F_{SW} : Switching Frequency Min 65 kHz:
- Hold time : Hold Time 20 ms, Hold Voltage 280 V

2 Inductor Selection

2.1 Calculating Inductance of L1

The inductance of L1 is calculated from the following equation,

$$L = V_{INMIN}^2 \times (V_{OUT} - 1.41 \times V_{INMIN}) \times \eta / (2 \times F_{SWMIN} \times P_{OUT} \times V_{OUT}) = 200 \mu H$$

where V_{INMIN} (Minimum Input Voltage) = 90 V , η (Efficiency) = 0.94 , F_{SWMIN} (Minimum Switching Frequency) = 65 kHz,

P_{OUT} (Maximum Output Power) = 200 W, V_{OUT} (Output Voltage) = 400 V.

Peak current of BCM is twice more than that of input current. Therefore,

$$I_{LPK} = P_o / V_{IN} / \eta \times 1.41 \times 2 = 6.67 \text{ A}$$

Adopt Generic Inductor for PFC from TDK (180 μ H, PFC3819QM-181K09B-50).

Calculation of switching frequency

t_{on} and t_{off} is calculated from the following equation,

$$I_{LPK} = V_{INDCMIN} / L \times t_{ON} = (V_{OUT} - V_{INDCMIN}) / L \times t_{OFF}$$

Where $V_{INDCMIN} = 90 \times 1.41 = 127 \text{ V}$, $V_{OUT} = 400 \text{ V}$, $L = 180 \mu H$, $I_{LPK} = 6.67 \text{ A}$.

Therefore,

$$t_{on} = I_{LPK} \times L / V_{INDCMIN} = 6.67 \times 180 \mu / 127 = 9.45 \mu s$$

$$t_{off} = I_{LPK} \times L / (V_{OUT} - V_{INDCMIN}) = 6.67 \times 180 \mu / (400 - 127) = 4.40 \mu s$$

$$F_{SW} = 1 / (t_{ON} + t_{OFF}) = 1 / (9.45 + 4.40) = 72.2 \text{ kHz}$$

Design Overview – Continued

3 Selection of Diode

3.1 Flywheel Diode : D1

The fast recovery diode is used as flywheel diode. The reverse voltage applied to the diode is $V_{OUTMAX} = 416$ V. Consider the derating and select 600 V diode.

The RMS current of the diode is,

$$I_{DRMS} = 4 \times P_o / (3 \times \eta \times V_{IN}) \times \sqrt{(2 \times 1.41 \times V_{IN} / (3.14 \times V_{OUT}))} = 1.42 \text{ A}$$

where $P_o = 200$ W , $\eta = 0.94$, $V_{IN} = 90$ V , $V_{OUT} = 400$ V.

Diode which tolerate large peak forward current should be selected because inrush current at turn-on. Small noisy FRD is recommended.

Considering heat generation of parts, VRFS20TF6S (20 A / 600 V) is used.

4 Selection of MOSFET

4.1 MOSFET : Q1

Select the MOSFET which have small $R_{ds(on)}$ and is fast.

Absolute Maximum Ratings is calculated from the following equations.

$$V_{DSS} > V_{OUTMAX} / 0.8 = 520 \text{ V}$$

$$I_D > 2 \times 1.41 \times P_o / V_{INMIN} / \eta = 6.67 \text{ A}$$

RMS current flowing the MOSFET is

$$I_{QRMS} = 2 \times P_o / (3 \times \eta \times V_{INMIN}) \times \sqrt{(3 - 8 \times 1.41 \times V_{INMIN} / (3.14 \times V_{OUT}))} = 2.33 \text{ A}$$

Assuming that loss at $R_{DS(on)}$ is 0.9 W, $R_{DS(on)}$ is determined.

$$P_D = I_Q^2 \times R_{ds(on)}$$

$$R_{DS(on)} = P_D / I_Q^2 = 0.165 \text{ } \Omega$$

Considering the above conditions, R6024KNX ($V_{DS} = 600$ V , $I_D = 24$ A , $R_{DS(on)} = 0.15$ Ω) is used.

Design Overview – Continued

5 Selection of Capacitor

5.1 Input Capacitor : C4

The input capacitor is used for noise measures.
 Film capacitor is used.
 Rated voltage is over $V_{INMAX} \times 1.41 = 373$ V.
 Capacitance is 1 μ F.

5.2 VCC Capacitor : C19

The VCC capacitor is required for stable operation of the IC.
 Rated voltage over 25 V and capacitance 1.0 μ F ~ 100 μ F should be used.
 Here, we use the capacitor which has rated voltage 50 V and capacitance 100 μ F.

5.3 Output capacitor : C5

For the output capacitor, select output voltage V_o of 450 V or more in consideration of derating.
 Capacitance is determined from both output ripple voltage and hold time.

From output ripple voltage,

$$C5 \geq I_o / (2 \times 3.14 \times f_{LINE} \times V_R) = 80 \mu F$$
 where $I_o = 0.5$ A , $f_{LINE} = 50$ Hz, $V_R = 20$ V.

From hold time,

$$C5 \geq 2 \times P_o \times T_{HOLD} / (V_o^2 - V_{oMIN}^2) = 116 \mu F$$
 where T_{HOLD} (Hold time) = 20 ms , $V_o = 384$ V , $V_{oMIN} = 280$ V.

Capacitance should be more than 116 μ F , therefore 150 μ F is selected.

We add a 0.33 μ F / 630 V ceramic capacitor in parallel to reduce output switching noise.

6 Selection of Resistor

6.1 Resistor determining output voltage : R1, R2, R3, R4

V_S of BD7692FJ is 2.5 V, and output voltage is determined from the following equation.

$$V_{OUT} = V_S \times (1 + (R1 + R2) / (R3 // R4))$$

R3 and R4 are selected after R1 and R2 are selected.

Selecting $R1 = R2 = 1$ M Ω ,

$$V_{OUT} / V_S - 1 = (R1 + R2) / (R3 // R4)$$

$$R3 // R4 = (R1 + R2) / (V_{OUT} / V_S - 1)$$

Substituting $V_{OUT} = 400$ V , $V_S = 2.5$ V , $R1 = R2 = 1$ M Ω ,

$$R3 // R4 = 12.58$$
 k Ω

Selecting $R3 = 13$ k Ω , $R4$ is determined to be 390 k Ω .

Design Overview – Continued

6.2 OVP resistor : R5, R6, R7

Over voltage protection function operates when OVP terminal voltage exceeds typical OVP voltage by abnormal operation of VS feedback circuit. Switching operation is stopped 60µs typ after OVP terminal voltage exceeds 2.7 Vtyp. Over voltage protection voltage is $2.7 \times (R5 + R6) / R7$.

Assuming that Over voltage protection voltage = 418 V , R5 = R6 = 1 MΩ , R7 is determined to be 13 kΩ.

6.3 RT terminal : R9 (RIS)

RT terminal determine maximum ON time and maximum frequency.

$$ton_Max = 2 \times L \times Po / (Vinmin^2 \times \eta)$$

Assuming that L = 180 µH , Po = 200 W , VINMIN = 90 V , η = 0.94 , ton_Max is determined to be 9.5 µs.

Select R9 = 120 kΩ.

R _{RT} (kΩ)	f _{MAXDUTY} (kHz)	t _{MAXDUTY} (µs)	t _{ZCDD} (µs)
39	580	10	1.10
68	500	15	1.20
120	450	20	1.35
220	420	25	1.40
470	410	30	1.45

*These table and graph mentioned above are reference value. After the confirmation of the actual board, please set the fixed number.
 *The characteristic kind to fluctuate by RT resistance is only five kinds. When RT resistance is set other than the resistor value mentioned above, it becomes the factor of the unstable operation.

6.4 Resistor connected to IS terminal : R14, R15, R16

Zero Current Detection and Over Current Detection

Zero Current Detection circuit detects zero crossing of inductor current.

When IS terminal voltage becomes higher than ZCD voltage, OUT terminal voltage becomes high with a delay of ZCD delay time (1.5 µs typ).

Resistance is selected in order that over current detection voltage is - 0.6 V typ or less.

$$RIS \leq 0.6 / IPK = 0.6 / 6.67 = 0.09 \Omega$$

Considering wiring resistance of PCB, R14, R15 and R16 are all 0.2 Ω.

Resistor loss is $I^2 \times R$.

$$2.33^2 \times 0.067 = 0.36 W$$

Considering margin, it is 2 W or more in total.

6.5 Phase Compensation Capacitor of GmAMP : C7,C8,R8

C7 = 0.47 µF , C8 = 1 µF , R6 = 10 kΩ are selected.

Performance Data

Constant Load Regulation

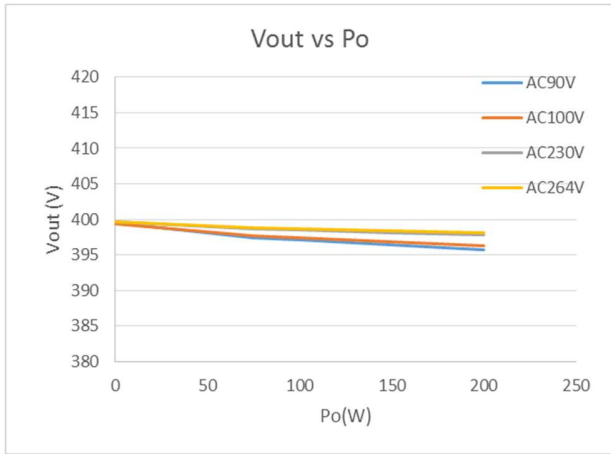

Figure 8. Load Regulation (P_o vs V_{OUT})

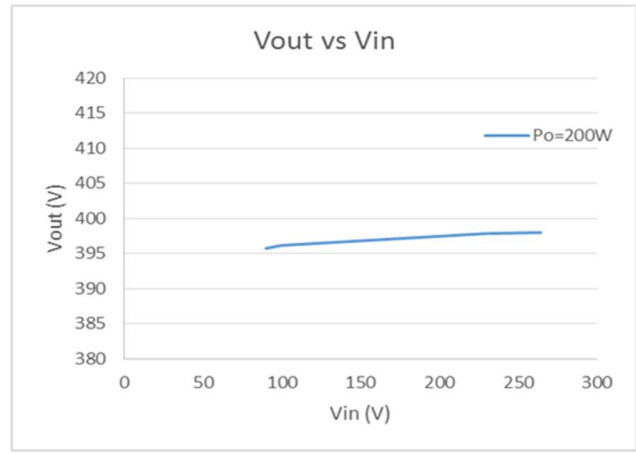

Figure 9. Line Regulation (V_{OUT} vs V_{IN})

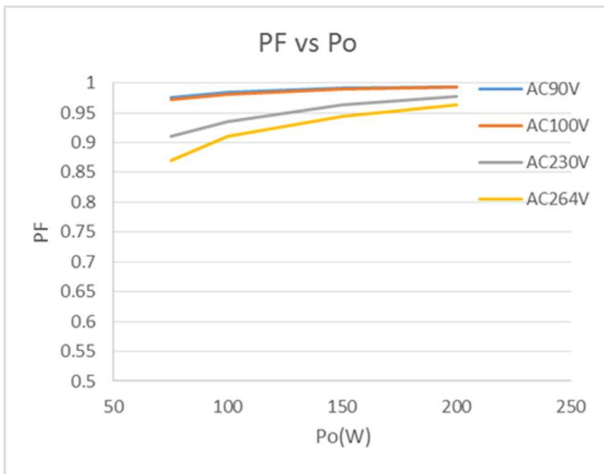

Figure 10. PF (PF vs P_o)

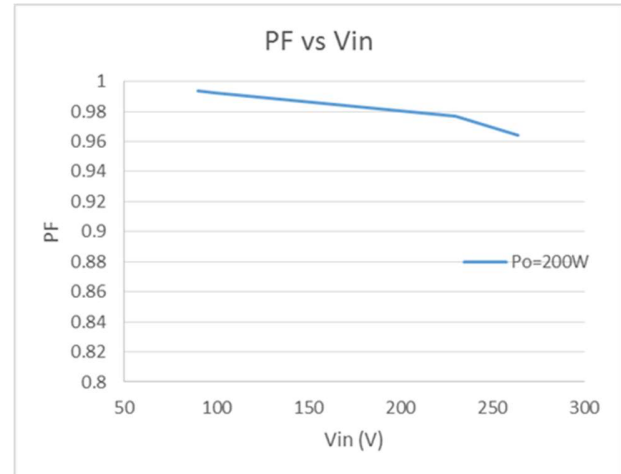

Figure 11. PF (PF vs V_{IN})

Performance data – Continued

Efficiency

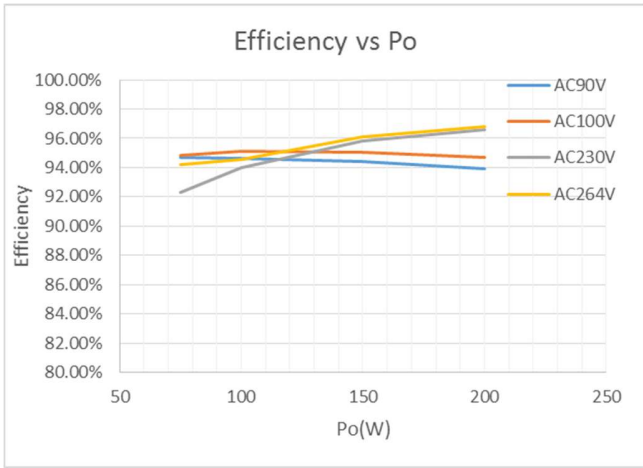

Figure 12. Efficiency (Efficiency vs P_o)

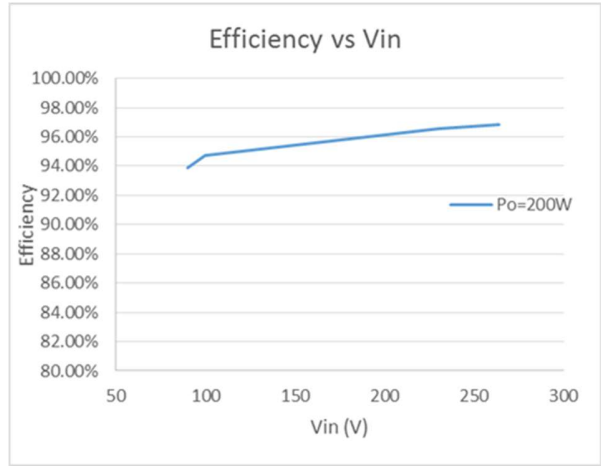

Figure 13. Efficiency (Efficiency vs V_{IN})

Harmonic Current

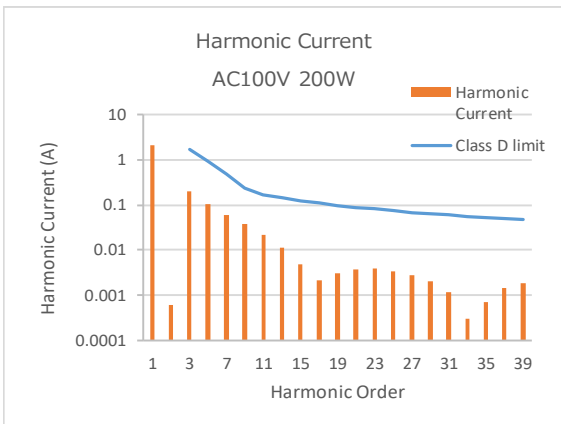

Figure 14. Harmonic Current (V_{IN} 100 V_{ac})

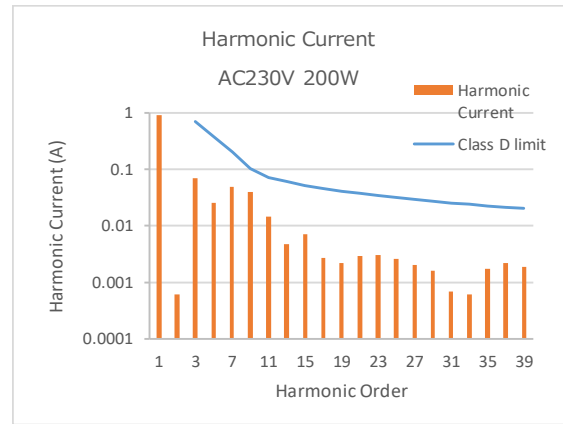

Figure 15. Harmonic Current (V_{IN} 230 V_{ac})

Performance Data – Continued

Input Current

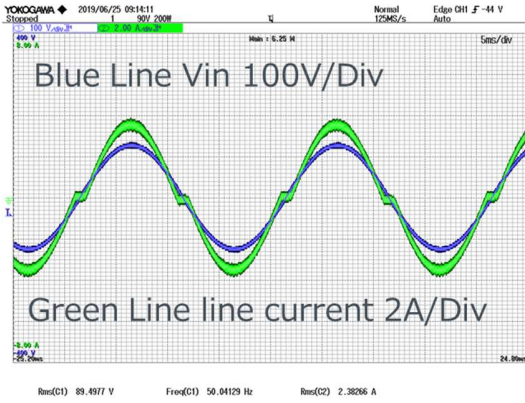

Figure 16. Input Current $V_{IN} = 100 V_{ac}$, $I_{OUT} = 0.5 A$

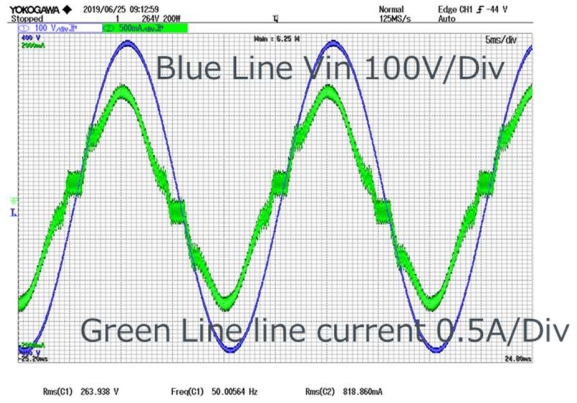

Figure 17. Input Current $V_{IN} = 230 V_{ac}$, $I_{OUT} = 0.5 A$

V_{DS} , I_D WaveForm $V_{IN} = 90 V_{ac}$ $I_o = 0.5 A$

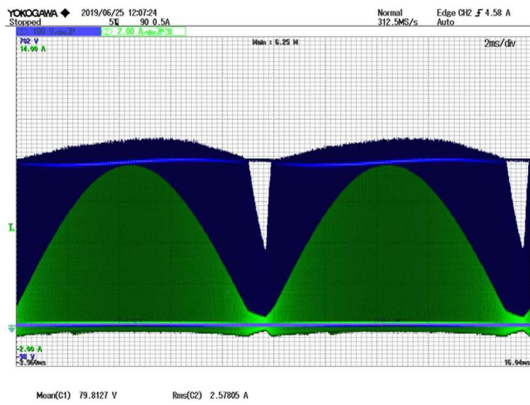

Figure 18. V_{DS}, I_D $V_{IN} = 90 V_{ac}$ $I_{OUT} = 0.5 A$



Figure 19. V_{DS}, I_D ZOOM

Performance Data – Continued

Hold time

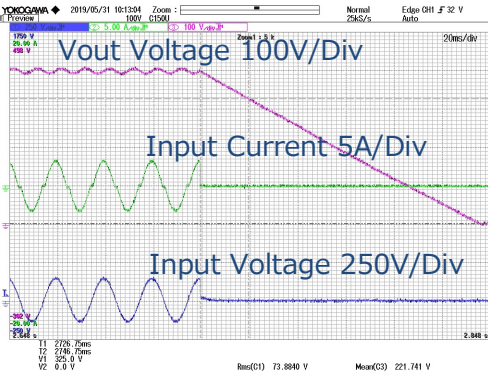

Figure 20. Hold time

Start Up $I_o = 0.5\text{ A}$

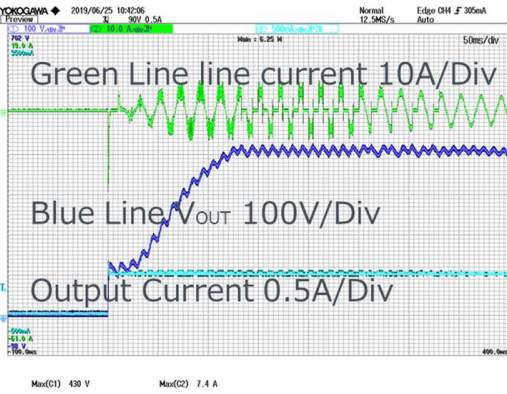

Figure 21. Start Up $V_{IN} = 90\text{ V}_{ac}$

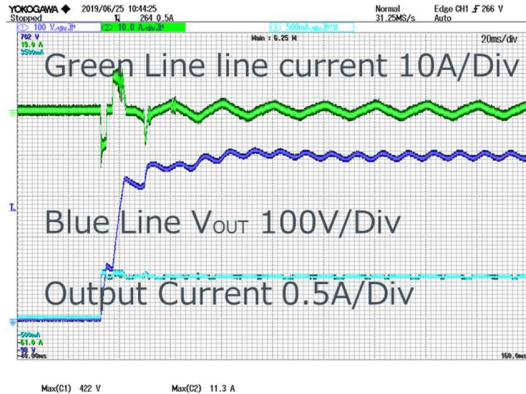

Figure 22. Start Up $V_{IN} = 264\text{ V}_{ac}$

Performance Data - Continued

Load Transient $I_o = 0.05\text{ A} \leftrightarrow 0.5\text{ A}$

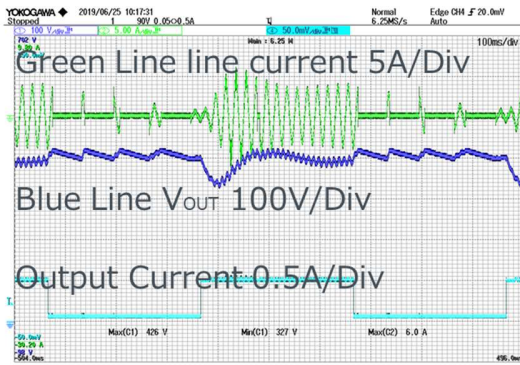

Figure 23. Load Transient $V_{IN} = 90\text{ V}_{dc}$

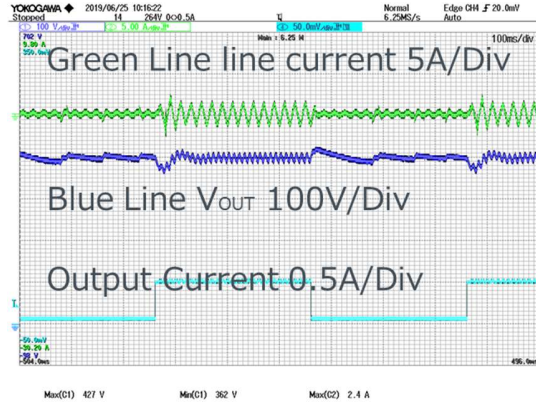

Figure 24. Load Transient $V_{IN} = 264\text{ V}_{dc}$

Output ripple $I_o = 0.5\text{ A}$

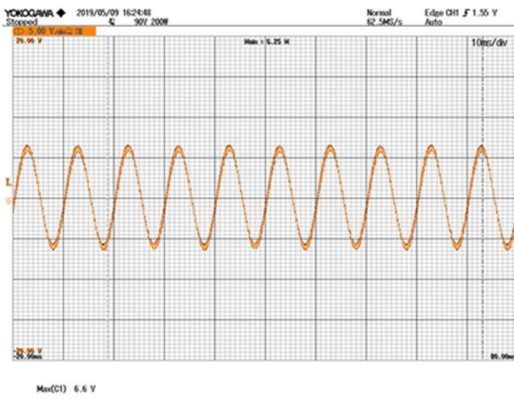

Figure 25. Output ripple $V_{IN} = 90\text{ V}_{dc}$

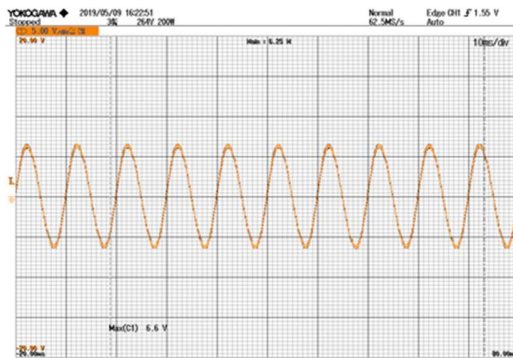

Figure 26. Output ripple $V_{IN} = 264\text{ V}_{dc}$

Performance Data - Continued

EMI

•Conducted Emission: CISPR22 Pub 22 Class B

Limit1 : CISPR Pub 22 Class B
Limit2 : CISPR Pub 22 Class B (AV)

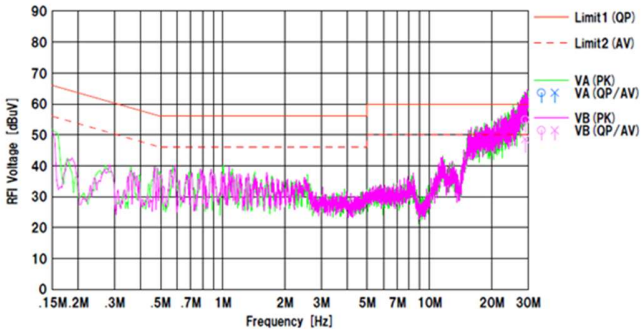

Figure 27. $V_{IN} = 100 V_{ac} / 60 Hz, I_{OUT} = 0.5 A$

Limit1 : CISPR Pub 22 Class B
Limit2 : CISPR Pub 22 Class B (AV)

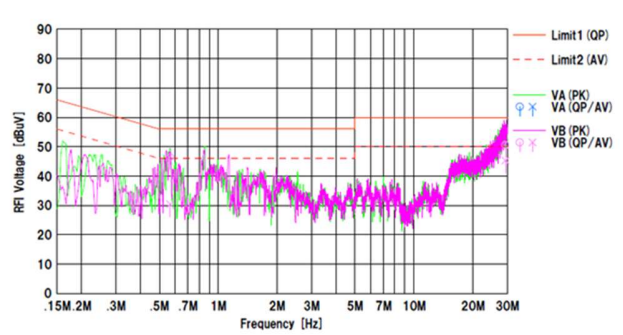

Figure 28. $V_{IN} = 230 V_{ac} / 60 Hz, I_{OUT} = 0.5 A$

Notes

- 1) The information contained herein is subject to change without notice.
- 2) Before you use our Products, please contact our sales representative and verify the latest specifications :
- 3) Although ROHM is continuously working to improve product reliability and quality, semiconductors can break down and malfunction due to various factors.
Therefore, in order to prevent personal injury or fire arising from failure, please take safety measures such as complying with the derating characteristics, implementing redundant and fire prevention designs, and utilizing backups and fail-safe procedures. ROHM shall have no responsibility for any damages arising out of the use of our Products beyond the rating specified by ROHM.
- 4) Examples of application circuits, circuit constants and any other information contained herein are provided only to illustrate the standard usage and operations of the Products. The peripheral conditions must be taken into account when designing circuits for mass production.
- 5) The technical information specified herein is intended only to show the typical functions of and examples of application circuits for the Products. ROHM does not grant you, explicitly or implicitly, any license to use or exercise intellectual property or other rights held by ROHM or any other parties. ROHM shall have no responsibility whatsoever for any dispute arising out of the use of such technical information.
- 6) The Products specified in this document are not designed to be radiation tolerant.
- 7) For use of our Products in applications requiring a high degree of reliability (as exemplified below), please contact and consult with a ROHM representative : transportation equipment (i.e. cars, ships, trains), primary communication equipment, traffic lights, fire/crime prevention, safety equipment, medical systems, servers, solar cells, and power transmission systems.
- 8) Do not use our Products in applications requiring extremely high reliability, such as aerospace equipment, nuclear power control systems, and submarine repeaters.
- 9) ROHM shall have no responsibility for any damages or injury arising from non-compliance with the recommended usage conditions and specifications contained herein.
- 10) ROHM has used reasonable care to ensure the accuracy of the information contained in this document. However, ROHM does not warrants that such information is error-free, and ROHM shall have no responsibility for any damages arising from any inaccuracy or misprint of such information.
- 11) Please use the Products in accordance with any applicable environmental laws and regulations, such as the RoHS Directive. For more details, including RoHS compatibility, please contact a ROHM sales office. ROHM shall have no responsibility for any damages or losses resulting non-compliance with any applicable laws or regulations.
- 12) When providing our Products and technologies contained in this document to other countries, you must abide by the procedures and provisions stipulated in all applicable export laws and regulations, including without limitation the US Export Administration Regulations and the Foreign Exchange and Foreign Trade Act.
- 13) This document, in part or in whole, may not be reprinted or reproduced without prior consent of ROHM.



Thank you for your accessing to ROHM product informations.
More detail product informations and catalogs are available, please contact us.

ROHM Customer Support System

<http://www.rohm.com/contact/>