

BAR64-02V

Low signal distortion, surface mount RF PIN diode



Order now



Technical documents



Simulation



Support

Product description

This Infineon cost optimized RF PIN diode is designed for low distortion switches that require to hold off large RF voltages, and is best suited for frequencies as high as 6 GHz. Its nominal 50 μm I-region width, combined with the typical 1.55 μs carrier lifetime, result in a diode with low forward resistance and low distortion characteristics.



Feature list

- Low signal distortion, charge carrier lifetime $t_{rr} = 1.55 \mu\text{s}$ (typical)
- Ultra low capacitance $C = 0.13 \text{ pF}$ (typical) at voltage $V_R = 0$ and frequencies $f \geq 1 \text{ GHz}$
- Low forward resistance $R_F = 2.1 \Omega$ (typical) at forward current $I_F = 10 \text{ mA}$ and frequency $f = 100 \text{ MHz}$
- Low inductance $L_s = 0.6 \text{ nH}$ (typical)
- Industry standard SC79 package (1.6 mm x 0.8 mm x 0.55 mm)
- Pb-free, RoHS compliant and halogen-free

Product validation

Qualified for industrial applications according to the relevant tests of JEDEC47/20/22.

Potential applications

Optimized for low bias current RF and high-speed interface switches and attenuators

- Wireless communication
- High speed data networks

Device information

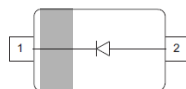

Table 1 Part information

| Product name / Ordering code | Package | Pin configuration | Marking | Pieces / Reel |
|--------------------------------|---------|--------------------|---------|---------------|
| BAR64-02V / BAR6402VH6327XTSA1 | SC79 | Single, with leads | 0 | 3 k |

Attention: ESD (Electrostatic discharge) sensitive device, observe handling precautions!

Table of contents

Table of contents

| | | |
|----------|---|----|
| | Product description | 1 |
| | Feature list | 1 |
| | Product validation | 1 |
| | Potential applications | 1 |
| | Device information | 1 |
| | Table of contents | 2 |
| 1 | Absolute maximum ratings | 2 |
| 2 | Electrical performance in test fixture | 3 |
| 2.1 | DC characteristics | 3 |
| 2.2 | AC characteristics | 4 |
| 3 | Thermal characteristics | 9 |
| 4 | Package information SC79 | 11 |
| | Revision history | 12 |
| | Disclaimer | 13 |

1 Absolute maximum ratings

Table 2 Absolute maximum ratings at $T_A = 25\text{ °C}$, unless otherwise specified

| Parameter | Symbol | Values | | Unit | Note or test condition |
|-------------------------|-----------|--------|------|------|--|
| | | Min. | Max. | | |
| Diode reverse voltage | V_R | – | 150 | V | |
| Forward current | I_F | – | 100 | mA | |
| Total power dissipation | P_{TOT} | – | 250 | mW | $T_S \leq 125\text{ °C}$ ¹⁾ |
| Junction temperature | T_J | – | 150 | °C | |
| Operating temperature | T_{OP} | -55 | 125 | | |
| Storage temperature | T_{STG} | -55 | 150 | | |

Attention: *Stresses above the maximum values listed here may cause permanent damage to the device. Exposure to absolute maximum rating conditions for extended periods may affect device reliability. Exceeding only one of these values may cause irreversible damage to the component.*

¹ T_S is the soldering point temperature.

Electrical performance in test fixture

2 Electrical performance in test fixture

2.1 DC characteristics

At $T_A = 25\text{ }^\circ\text{C}$, unless otherwise specified

Table 3 DC characteristics

| Parameter | Symbol | Values | | | Unit | Note or test condition |
|-------------------|----------|--------|------|------|---------------|------------------------------|
| | | Min. | Typ. | Max. | | |
| Breakdown voltage | V_{BR} | 150 | – | – | V | $I_R = 5\text{ }\mu\text{A}$ |
| Reverse current | I_R | – | – | 20 | nA | $V_R = 20\text{ V}$ |
| Forward voltage | V_F | – | 0.82 | – | V | $I_F = 10\text{ mA}$ |
| | | – | 0.9 | – | | $I_F = 50\text{ mA}$ |
| | | – | 0.95 | 1.1 | | $I_F = 100\text{ mA}$ |
| I-region width | W_I | – | 50 | – | μm | |

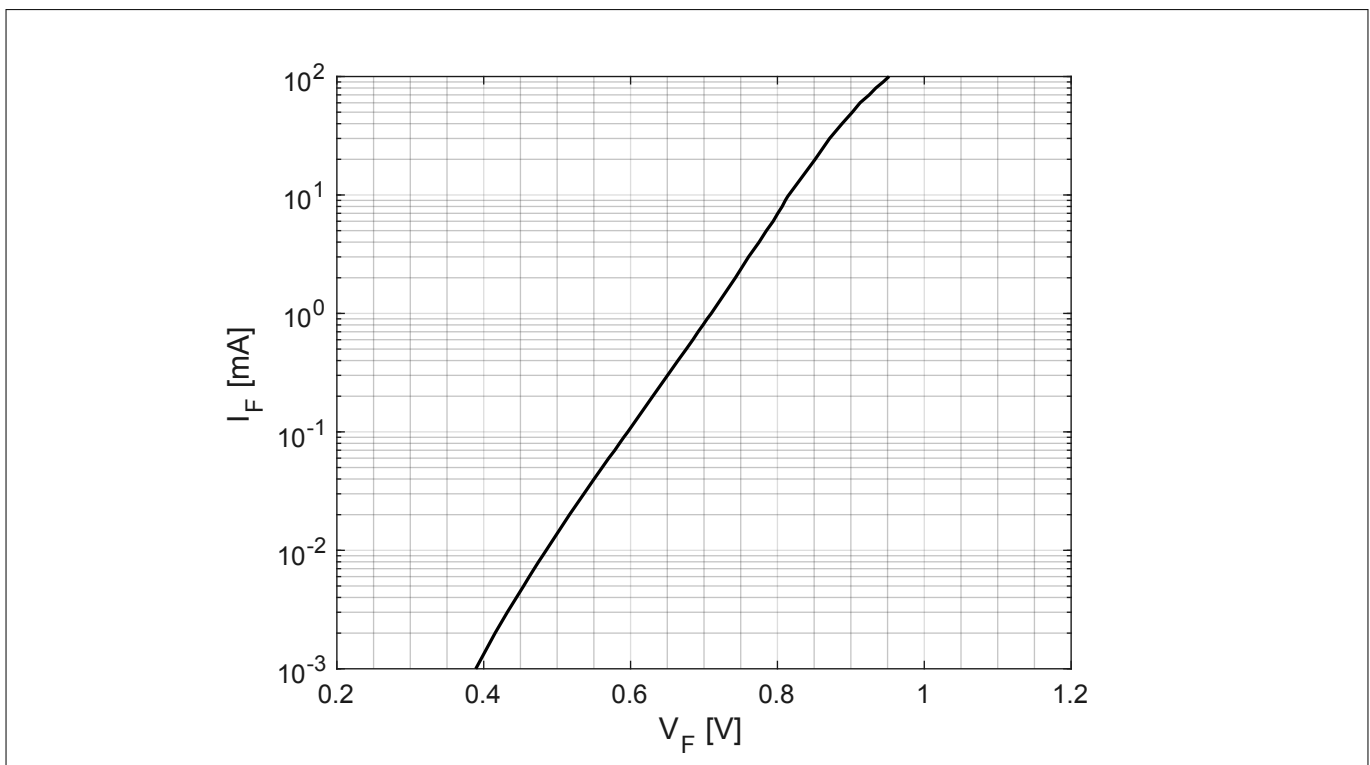

Figure 1 Forward current I_F vs. forward voltage V_F

Electrical performance in test fixture

2.2 AC characteristics

At $T_A = 25\text{ }^\circ\text{C}$, unless otherwise specified

Table 4 Key parameter

| Parameter | Symbol | Values | | | Unit | Note or test condition |
|-------------------------|-------------|--------|------|------|----------|---|
| | | Min. | Typ. | Max. | | |
| Capacitance | C | - | 0.56 | - | pF | $V_R = 0\text{ V}, f = 1\text{ MHz}$ |
| | | - | 0.2 | 0.35 | | $V_R = 20\text{ V}, f = 1\text{ MHz}$ |
| Forward resistance | R_F | - | 10.1 | 20 | Ω | $I_F = 1\text{ mA}, f = 100\text{ MHz}$ |
| | | - | 4.3 | - | | $I_F = 3\text{ mA}, f = 100\text{ MHz}$ |
| | | - | 3.1 | - | | $I_F = 5\text{ mA}, f = 100\text{ MHz}$ |
| | | - | 2.1 | 2.8 | | $I_F = 10\text{ mA}, f = 100\text{ MHz}$ |
| | | - | - | 1.35 | | $I_F = 100\text{ mA}, f = 100\text{ MHz}$ |
| Inductance | L_S | - | 0.6 | - | nH | |
| Charge carrier lifetime | τ_{rr} | - | 1550 | - | ns | $I_F = 10\text{ mA}, I_R = 6\text{ mA}$, measured at $I_R = 3\text{ mA}$, $R_L = 100\ \Omega$ |

Table 5 AC parameter at $f = 1\text{ GHz}$

| Parameter | Symbol | Values | | | Unit | Note or test condition |
|-----------------------------|----------|--------|------|------|------------|------------------------|
| | | Min. | Typ. | Max. | | |
| Capacitance | C | - | 0.13 | - | pF | $V_R = 0\text{ V}$ |
| Reverse parallel resistance | R_P | - | 3.9 | - | k Ω | $V_R = 0\text{ V}$ |
| Forward resistance | R_F | - | 9.6 | - | Ω | $I_F = 1\text{ mA}$ |
| | | - | 4.3 | - | | $I_F = 3\text{ mA}$ |
| | | - | 3.1 | - | | $I_F = 5\text{ mA}$ |
| | | - | 2.2 | - | | $I_F = 10\text{ mA}$ |
| Insertion loss | I_L | - | 0.79 | - | dB | $I_F = 1\text{ mA}$ |
| | | - | 0.37 | - | | $I_F = 3\text{ mA}$ |
| | | - | 0.28 | - | | $I_F = 5\text{ mA}$ |
| | | - | 0.2 | - | | $I_F = 10\text{ mA}$ |
| Isolation | I_{SO} | - | 22.4 | - | | $V_R = 0\text{ V}$ |

Table 6 AC parameter at $f = 1.8\text{ GHz}$

| Parameter | Symbol | Values | | | Unit | Note or test condition |
|-----------------------------|--------|--------|------|------|------------|------------------------|
| | | Min. | Typ. | Max. | | |
| Capacitance | C | - | 0.12 | - | pF | $V_R = 0\text{ V}$ |
| Reverse parallel resistance | R_P | - | 3.3 | - | k Ω | $V_R = 0\text{ V}$ |

Electrical performance in test fixture

Table 6 AC parameter at $f = 1.8$ GHz (continued)

| Parameter | Symbol | Values | | | Unit | Note or test condition |
|--------------------|----------|--------|------|------|----------|------------------------|
| | | Min. | Typ. | Max. | | |
| Forward resistance | R_F | - | 9.6 | - | Ω | $I_F = 1$ mA |
| | | - | 4.3 | - | | $I_F = 3$ mA |
| | | - | 3.2 | - | | $I_F = 5$ mA |
| | | - | 2.3 | - | | $I_F = 10$ mA |
| Insertion loss | I_L | - | 0.8 | - | dB | $I_F = 1$ mA |
| | | - | 0.39 | - | | $I_F = 3$ mA |
| | | - | 0.3 | - | | $I_F = 5$ mA |
| | | - | 0.23 | - | | $I_F = 10$ mA |
| Isolation | I_{SO} | - | 17.7 | - | | $V_R = 0$ V |

Table 7 AC parameter at $f = 2.5$ GHz

| Parameter | Symbol | Values | | | Unit | Note or test condition |
|-----------------------------|----------|--------|------|------|------------|------------------------|
| | | Min. | Typ. | Max. | | |
| Capacitance | C | - | 0.12 | - | pF | $V_R = 0$ V |
| Reverse parallel resistance | R_P | - | 3 | - | k Ω | $V_R = 0$ V |
| Forward resistance | R_F | - | 9.7 | - | Ω | $I_F = 1$ mA |
| | | - | 4.4 | - | | $I_F = 3$ mA |
| | | - | 3.3 | - | | $I_F = 5$ mA |
| | | - | 2.4 | - | | $I_F = 10$ mA |
| Insertion loss | I_L | - | 0.82 | - | dB | $I_F = 1$ mA |
| | | - | 0.42 | - | | $I_F = 3$ mA |
| | | - | 0.33 | - | | $I_F = 5$ mA |
| | | - | 0.26 | - | | $I_F = 10$ mA |
| Isolation | I_{SO} | - | 15.1 | - | | $V_R = 0$ V |

Table 8 AC parameter at $f = 5.5$ GHz

| Parameter | Symbol | Values | | | Unit | Note or test condition |
|----------------|----------|--------|------|------|------|------------------------|
| | | Min. | Typ. | Max. | | |
| Insertion loss | I_L | - | 1.03 | - | dB | $I_F = 1$ mA |
| | | - | 0.64 | - | | $I_F = 3$ mA |
| | | - | 0.56 | - | | $I_F = 5$ mA |
| | | - | 0.49 | - | | $I_F = 10$ mA |
| Isolation | I_{SO} | - | 7.7 | - | | $V_R = 0$ V |

Electrical performance in test fixture

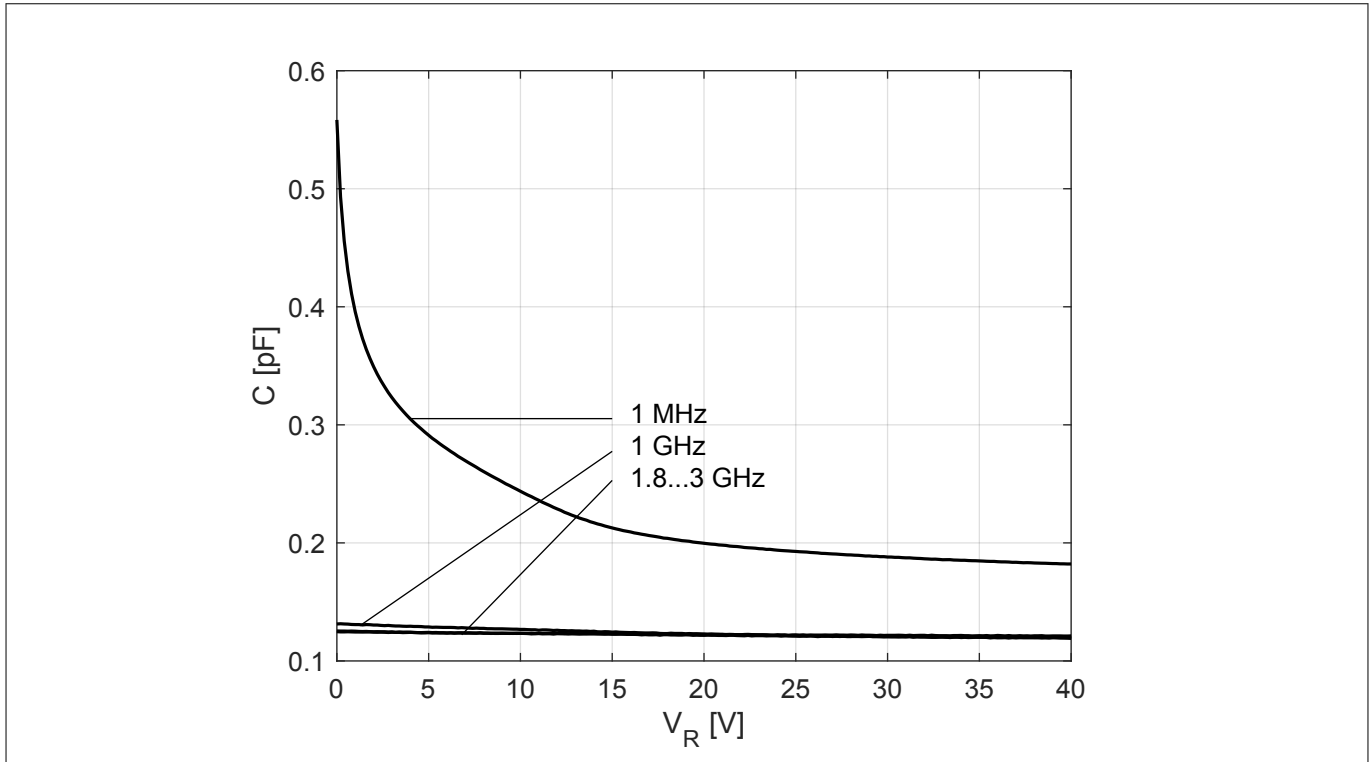

Figure 2 Capacitance C vs. reverse voltage V_R at different frequencies

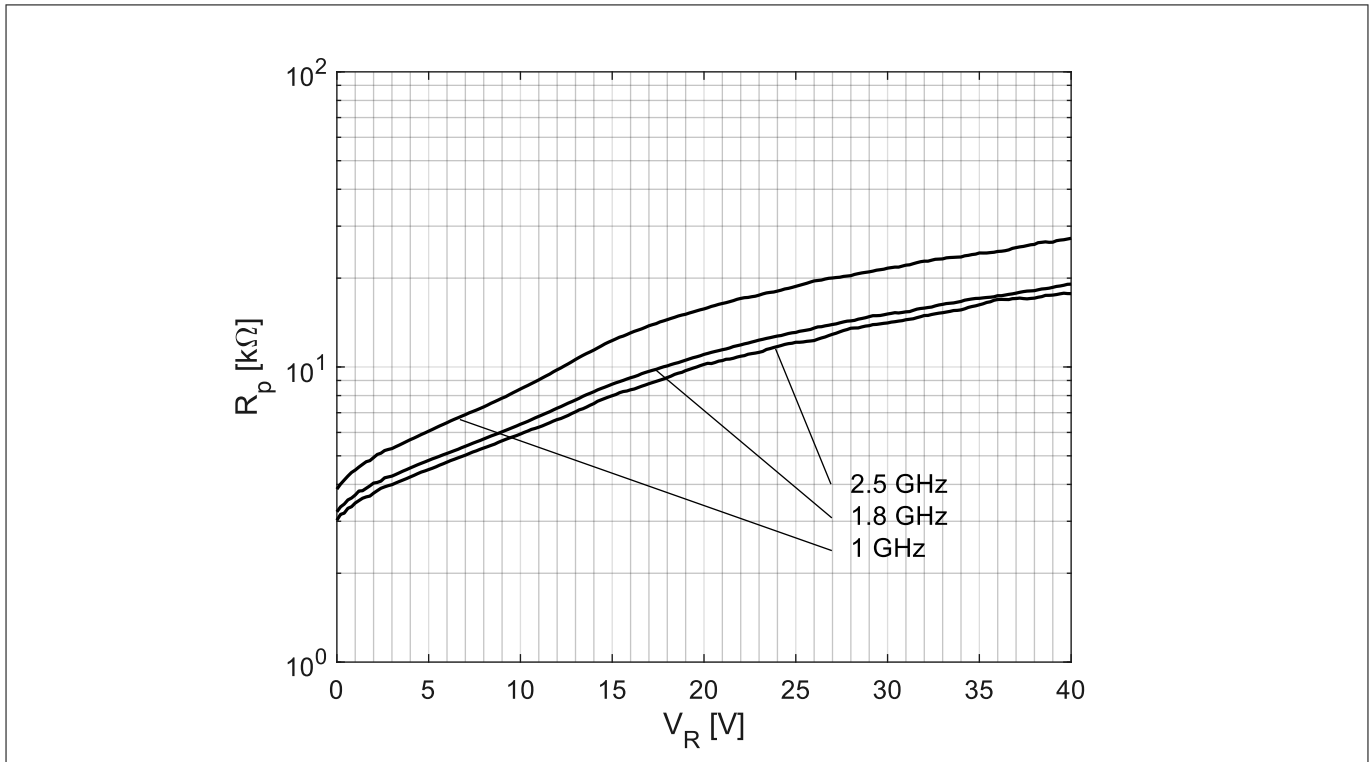

Figure 3 Reverse parallel resistance R_p vs. reverse voltage V_R at different frequencies

Electrical performance in test fixture

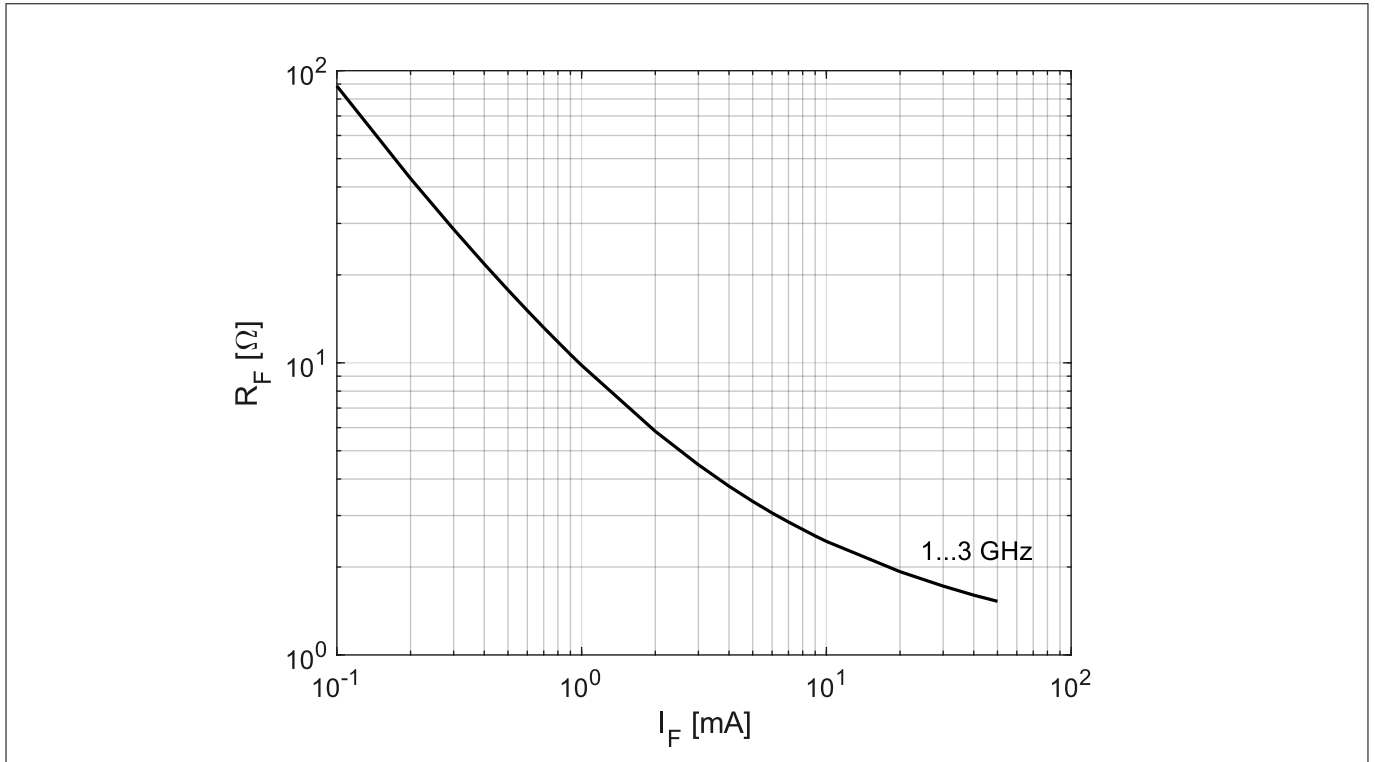

Figure 4 Forward resistance R_F vs. forward current I_F at different frequencies

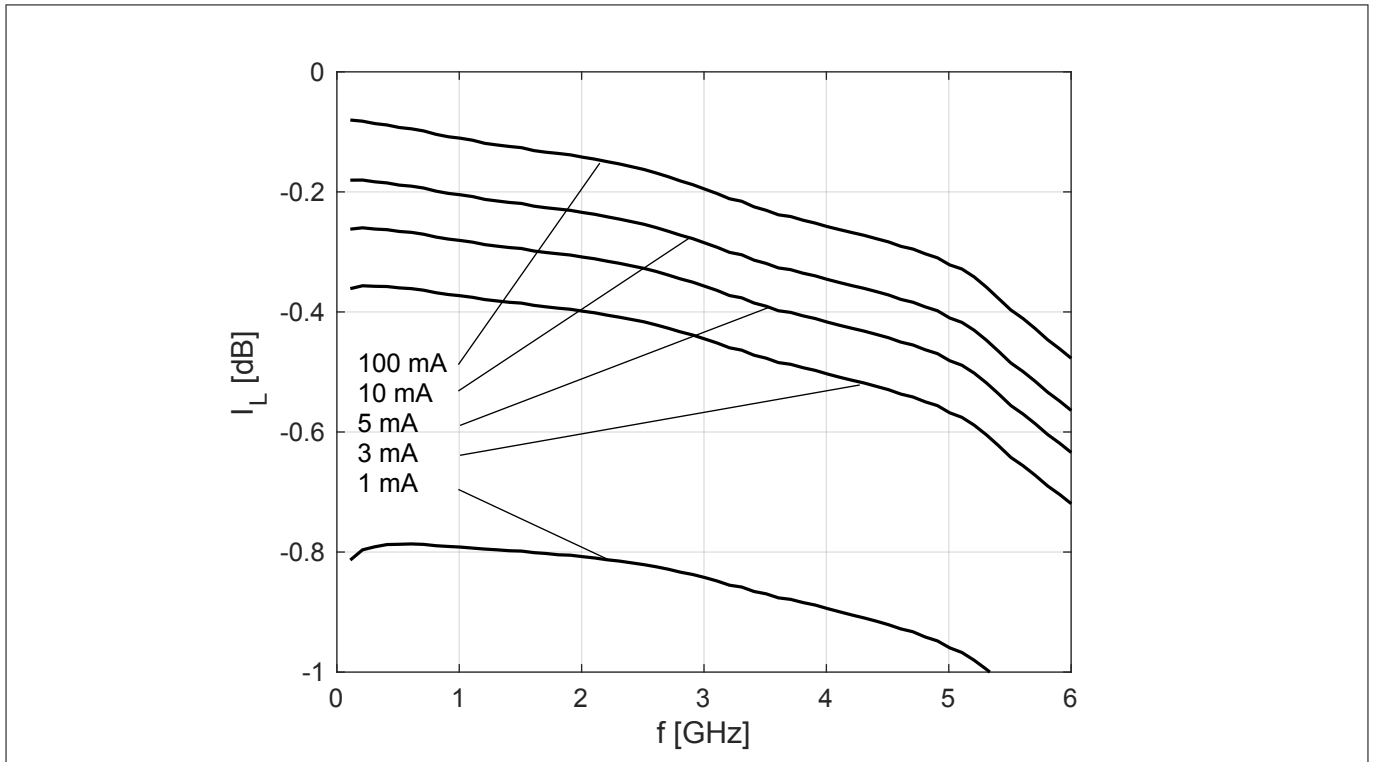

Figure 5 Insertion loss I_L vs. frequency f at different forward currents

Electrical performance in test fixture

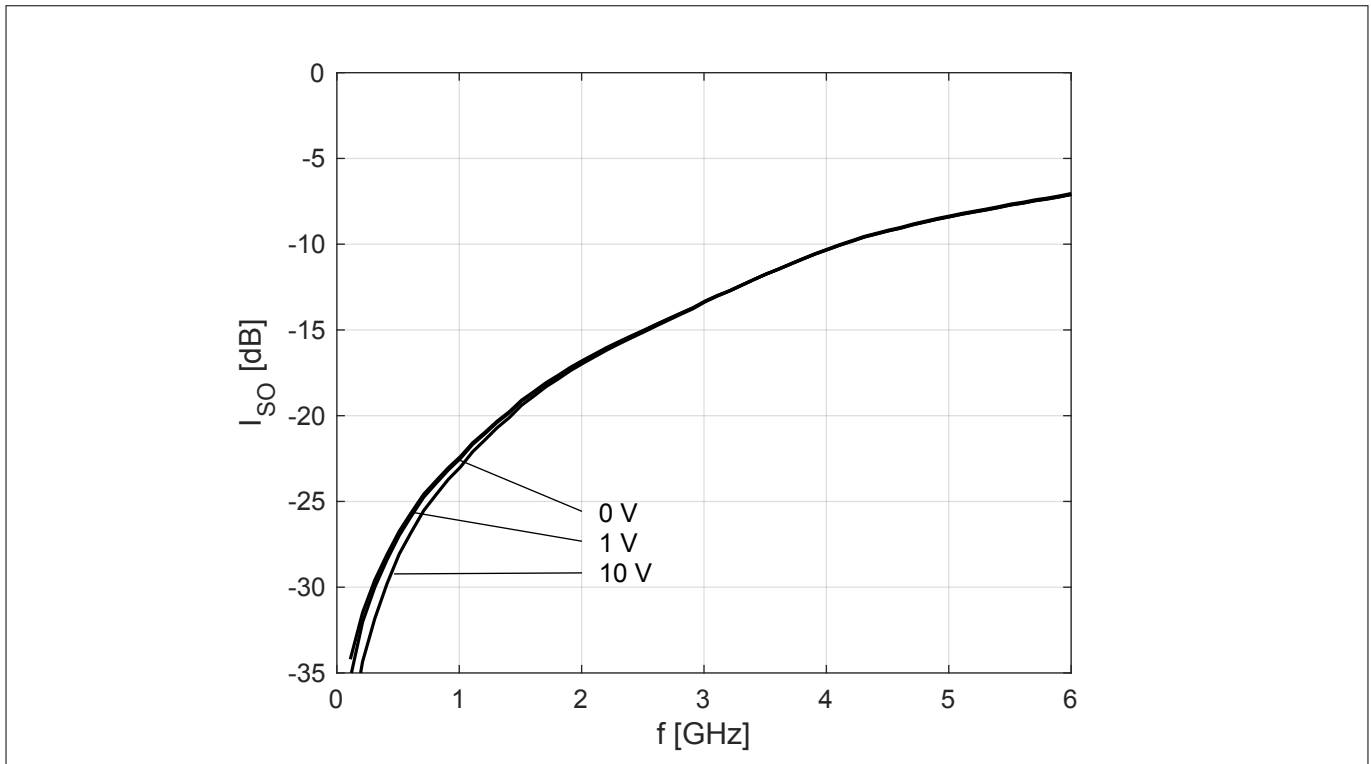

Figure 6 Isolation I_{SO} vs. frequency f at different reverse voltages

Note: The curves shown in this chapter have been generated using typical devices but shall not be understood as a guarantee that all devices have identical characteristic curves.

Thermal characteristics

3 Thermal characteristics

Table 9 Thermal resistance

| Parameter | Symbol | Values | | | Unit | Note or test condition |
|---|------------|--------|------|------|------|-------------------------------------|
| | | Min. | Typ. | Max. | | |
| Thermal resistance (junction - soldering point) | R_{thJS} | - | 100 | - | K/W | $T_S = 125\text{ °C}$ ²⁾ |

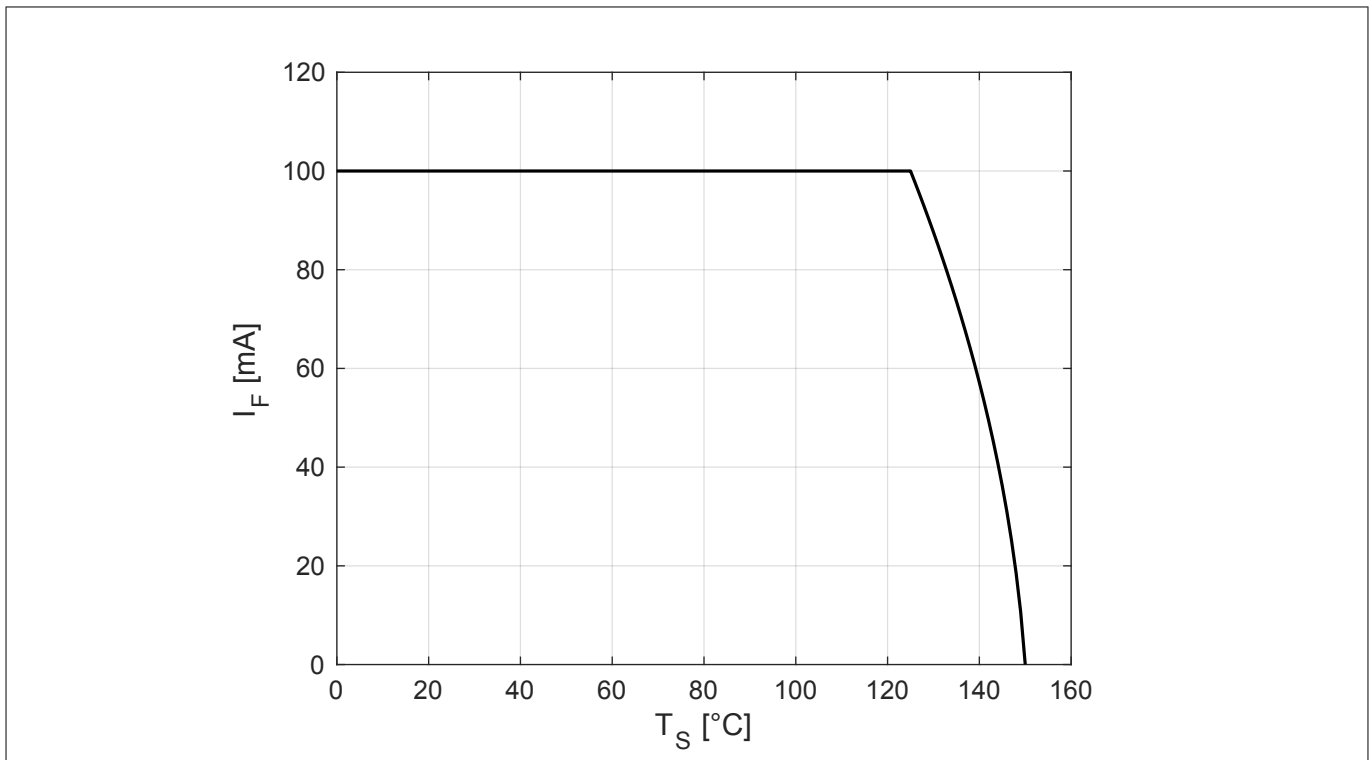

Figure 7 Permissible forward current I_F in DC operation

² For R_{thJS} in other conditions refer to the curves in this chapter.

Thermal characteristics

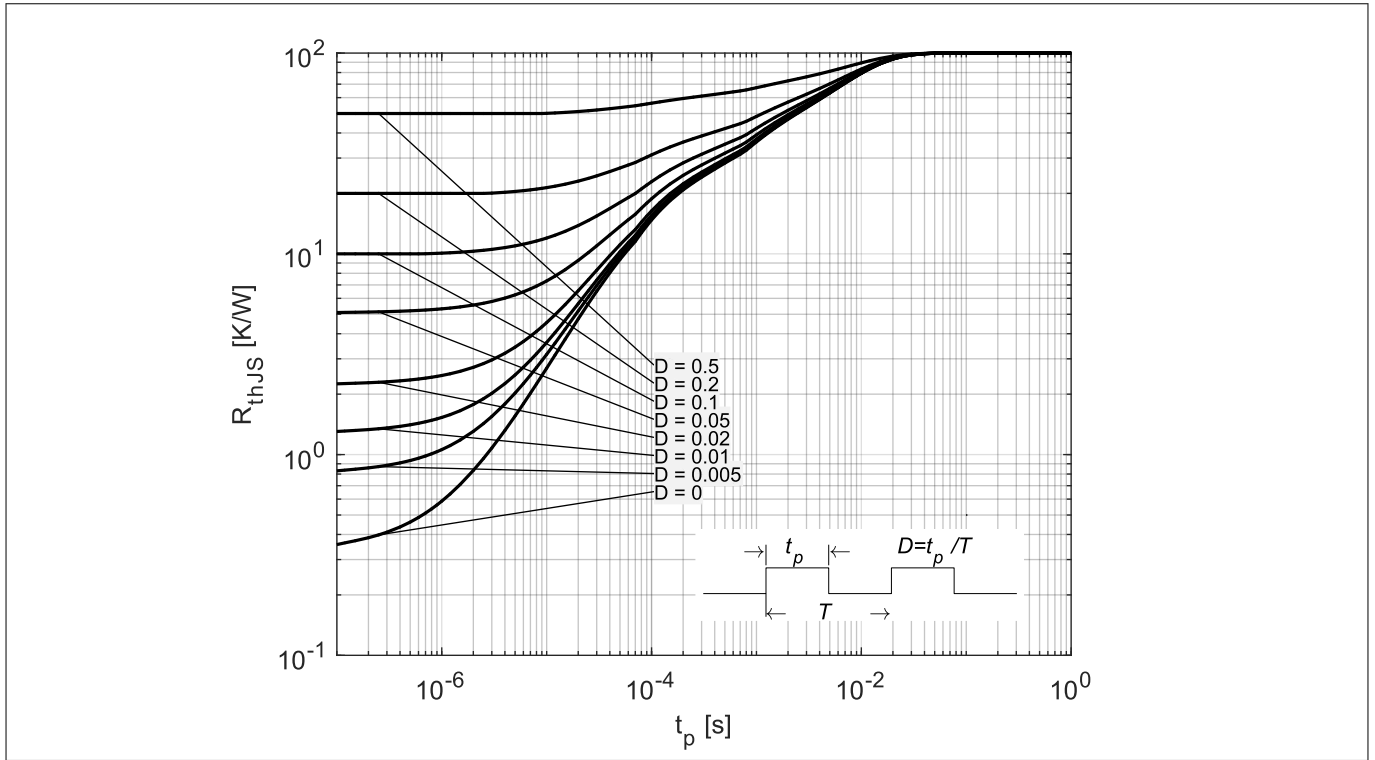

Figure 8 Thermal resistance R_{thJS} in pulse operation

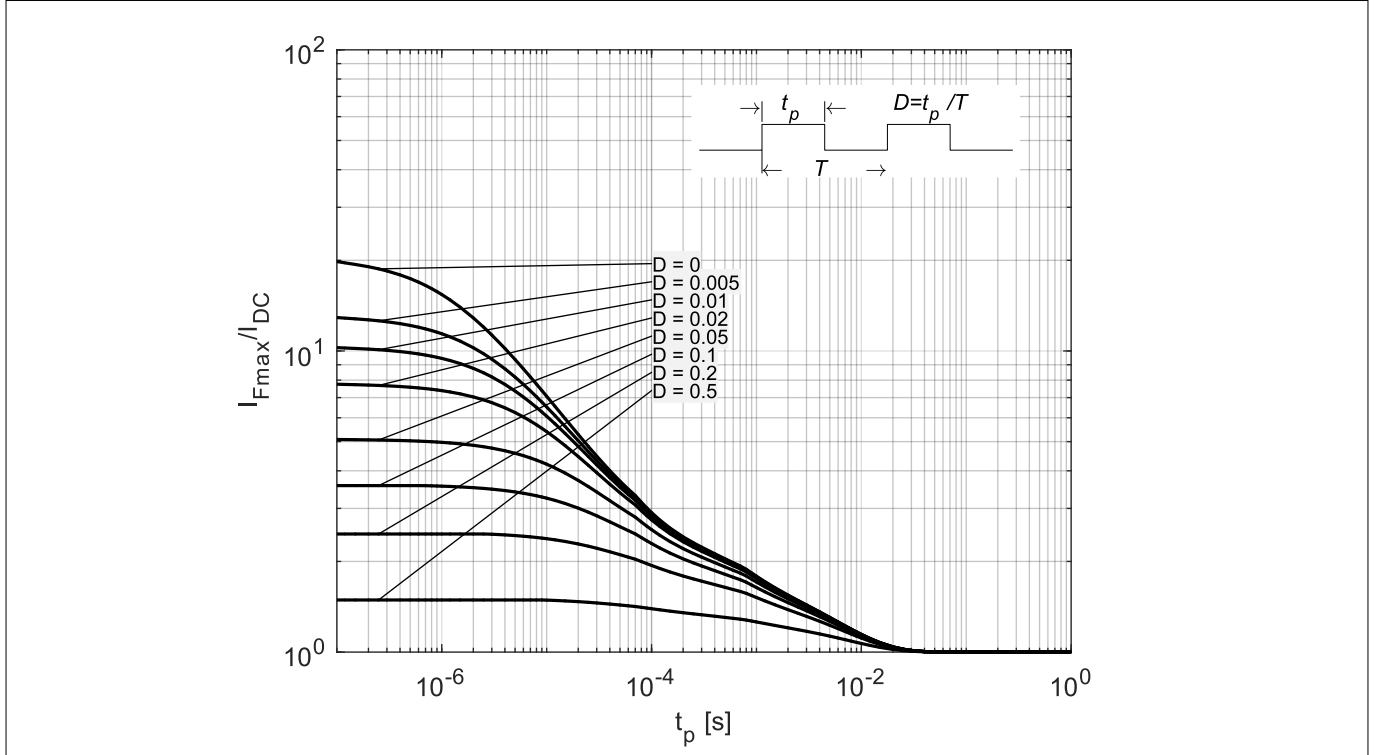

Figure 9 Permissible forward current ratio I_{Fmax} / I_{DC} in pulse operation

Package information SC79

4 Package information SC79

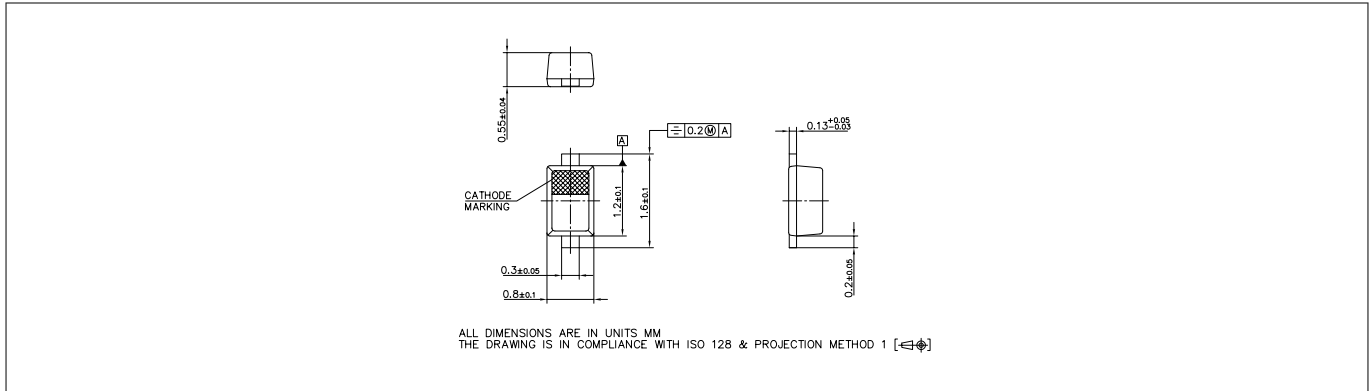

Figure 10 Package outline

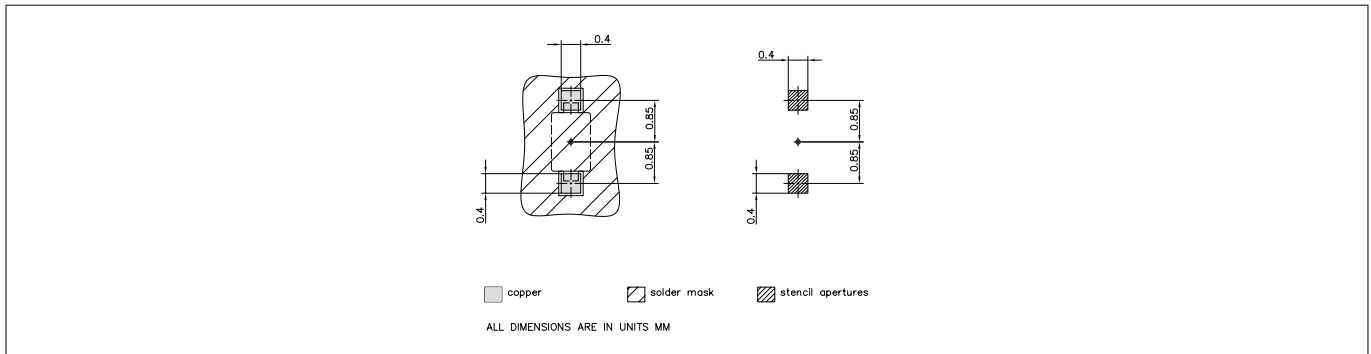

Figure 11 Foot print

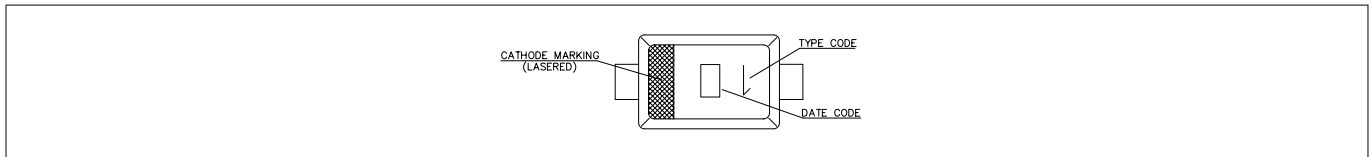

Figure 12 Marking layout

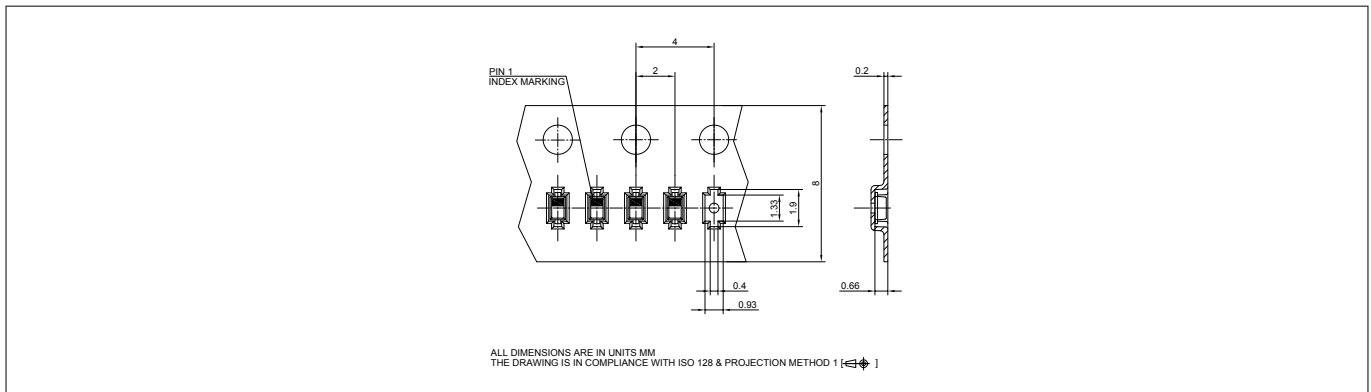

Figure 13 Tape dimensions

Revision history

Revision history

| Document version | Date of release | Description of changes |
|------------------|-----------------|--|
| 1.0 | 2018-09-07 | <ul style="list-style-type: none">• Change from series datasheet to individual one• Initial release of datasheet• Typical values and curves updated to the values of the production (No product or process change behind)• Maximum/typical values added• Typical curves/values removed |
| 1.1 | 2019-01-21 | Product description, feature list and potential application section reworked |

Trademarks

All referenced product or service names and trademarks are the property of their respective owners.

Edition 2018-06-30

Published by
Infineon Technologies AG
81726 Munich, Germany

© 2019 Infineon Technologies AG
All Rights Reserved.

Do you have a question about any
aspect of this document?
Email: erratum@infineon.com

Document reference
IFX-pmi1535438451692

IMPORTANT NOTICE

The information given in this document shall in no event be regarded as a guarantee of conditions or characteristics ("Beschaffheitsgarantie").

With respect to any examples, hints or any typical values stated herein and/or any information regarding the application of the product, Infineon Technologies hereby disclaims any and all warranties and liabilities of any kind, including without limitation warranties of non-infringement of intellectual property rights of any third party.

In addition, any information given in this document is subject to customer's compliance with its obligations stated in this document and any applicable legal requirements, norms and standards concerning customer's products and any use of the product of Infineon Technologies in customer's applications.

The data contained in this document is exclusively intended for technically trained staff. It is the responsibility of customer's technical departments to evaluate the suitability of the product for the intended application and the completeness of the product information given in this document with respect to such application.

WARNINGS

Due to technical requirements products may contain dangerous substances. For information on the types in question please contact your nearest Infineon Technologies office.

Except as otherwise explicitly approved by Infineon Technologies in a written document signed by authorized representatives of Infineon Technologies, Infineon Technologies' products may not be used in any applications where a failure of the product or any consequences of the use thereof can reasonably be expected to result in personal injury