

Micropower Precision Triple Supply Monitor with Push-Pull Reset Output in a 5-Lead SOT-23 Package

FEATURES

- **Monitors Three Inputs Simultaneously: 3V, 1.8V and Adjustable**
- **±1.5% Threshold Accuracy Over Temperature**
- **Very Low Supply Current: 10 μ A Typ**
- 200ms Reset Time Delay
- Power Supply Glitch Immunity
- Guaranteed $\overline{\text{RESET}}$ for $V_{\text{CC3}} \geq 1\text{V}$ or $V_{\text{CC18}} \geq 1\text{V}$
- **3V Active-Low Push-Pull Reset Output**
- 5-Lead SOT-23 Package

APPLICATIONS

- Desktop Computers
- Notebook Computers
- Intelligent Instruments
- Portable Battery-Powered Equipment
- Network Servers

DESCRIPTION

The LTC[®]1985-1.8 is a triple supply monitor intended for systems with multiple supply voltages. The reset output remains low until all three supplies have been in compliance for 200ms. Tight 1.5% accuracy specifications and glitch immunity ensure reliable reset operation without false triggering.

The $\overline{\text{RST}}$ output is guaranteed to be in the correct state for V_{CC18} or V_{CC3} down to 1V. The LTC1985 may also be configured to monitor any one or two V_{CC} inputs instead of three, depending on system requirements.

Very low (10 μ A typical) supply current makes the LTC1985 ideal for power conscious systems.

The LTC1985 is available in a 5-lead SOT-23 package.

 LTC and LT are registered trademarks of Linear Technology Corporation.

TYPICAL APPLICATION

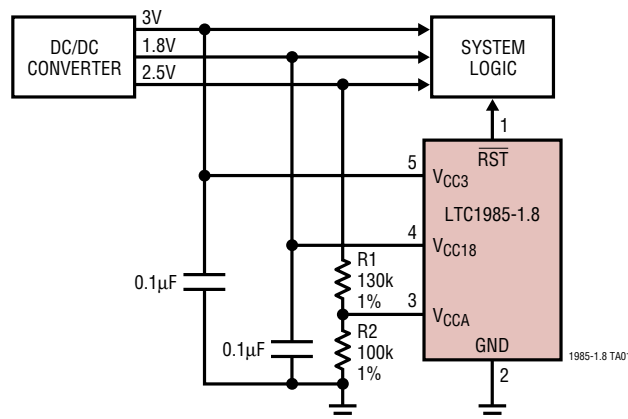

ABSOLUTE MAXIMUM RATINGS

(Notes 1, 2)

V_{CC3} , V_{CC18} , V_{CCA}	-0.3V to 7V
\overline{RST}	-0.3V to ($V_{CC3} + 0.3V$)
Operating Temperature Range (Note 3)	-40°C to 85°C
Storage Temperature Range	-65°C to 150°C
Lead Temperature (Soldering, 10 sec)	300°C

PACKAGE/ORDER INFORMATION

	ORDER PART NUMBER
	LTC1985ES5-1.8
	S5 PART MARKING
	LTNM

Consult factory for Industrial and Military grade parts.

ELECTRICAL CHARACTERISTICS

The ● denotes specifications which apply over the full operating temperature range, otherwise specifications are at $T_A = 25^\circ\text{C}$. $V_{CC3} = 3V$, $V_{CC18} = 1.8V$, $V_{CCA} = V_{CC3}$ unless otherwise noted.

SYMBOL	PARAMETER	CONDITIONS	MIN	TYP	MAX	UNITS
V_{RT3}	Reset Threshold V_{CC3}	V_{CC3} Input Threshold	● 2.760	2.805	2.850	V
V_{RT18}	Reset Threshold V_{CC18}	V_{CC18} Input Threshold	● 1.656	1.683	1.710	V
V_{RTA}	Reset Threshold V_{CCA}	V_{CCA} Input Threshold	● 0.985	1.000	1.015	V
V_{CCOP}	V_{CC3} , V_{CC18} Operating Voltage	\overline{RST} in Correct Logic State	● 1		7	V
I_{VCC3}	V_{CC3} Supply Current	$V_{CC18} > V_{CC3}$ $V_{CC18} < V_{CC3}$, $V_{CC3} = 3V$ (Note 4)	●	1 10	2 20	μA μA
I_{VCC18}	V_{CC18} Supply Current	$V_{CC18} < V_{CC3}$, $V_{CC18} = 1.8V$ (Note 4)	●	1	2	μA
I_{VCCA}	V_{CCA} Input Current	$V_{CCA} = 1V$	● -15	0	15	nA
t_{RST}	Reset Pulse Width	\overline{RST} Low (Note 5)	● 140	200	280	ms
t_{UV}	V_{CC} Undervoltage Detect to \overline{RST}	V_{CC18} , V_{CC3} or V_{CCA} Less Than Reset (Note 5) Threshold V_{RT} by More Than 1%		110		μs
V_{OL}	Output Voltage Low, \overline{RST}	$I_{SINK} = 2.5\text{mA}$, $V_{CC3} = 3V$, $V_{CC18} = 0V$ $I_{SINK} = 100\mu\text{A}$, $V_{CC3} = 1V$, $V_{CC18} = 0V$ $I_{SINK} = 100\mu\text{A}$, $V_{CC3} = 0V$, $V_{CC18} = 1V$ $I_{SINK} = 100\mu\text{A}$, $V_{CC3} = 1V$, $V_{CC18} = 1V$	●	0.15 0.05 0.05 0.05	0.4 0.3 0.3 0.3	V V V V
V_{OH}	Output Voltage High, \overline{RST}	$I_{SOURCE} = 200\mu\text{A}$	● 0.8	V_{CC3}		V

Note 1: Absolute Maximum Ratings are those values beyond which the life of the device may be impaired.

Note 2: All voltage values are with respect to GND.

Note 3: The LTC1985E is guaranteed to meet specified performance from 0°C to 70°C and is designed, characterized and assured to meet the

extended temperature limits of -40°C to 85°C but are not tested at these temperatures.

Note 4: Both V_{CC3} and V_{CC18} can act as the supply depending on which pin has the greatest potential.

Note 5: Measured from when input passes through the input threshold voltage (V_{RTX}) until \overline{RST} passes through 1.5V.

TYPICAL PERFORMANCE CHARACTERISTICS

I_{VCC3} vs Temperature

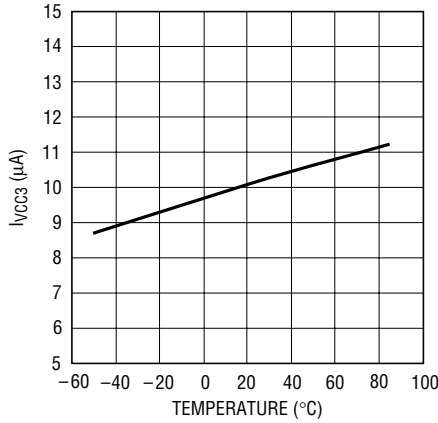

1985-18 G01

I_{VCC18} vs Temperature

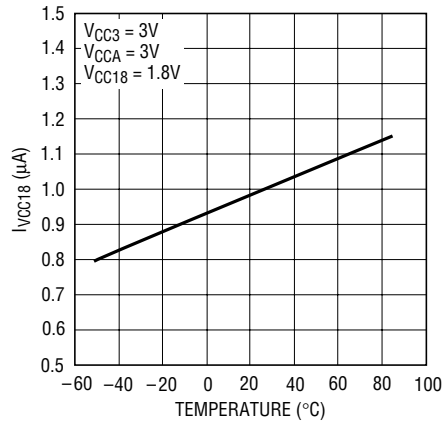

1985-18 G02

V_{CCA} Input Current vs Input Voltage

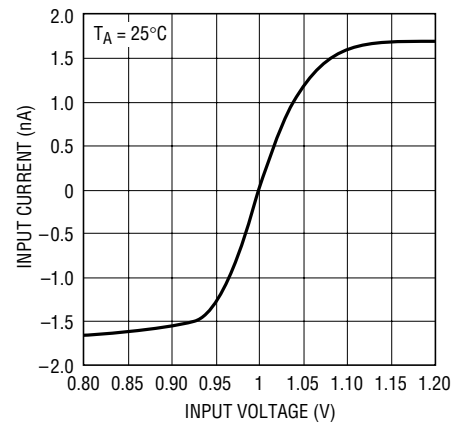

1985-18 G03

V_{CCA} Threshold Voltage vs Temperature

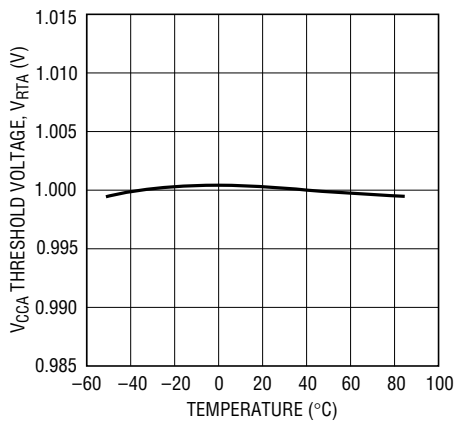

1985-18 G04

V_{CC3} Threshold Voltage vs Temperature

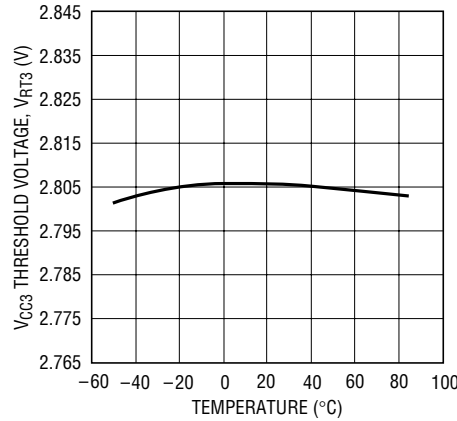

1985-18 G05

V_{CC18} Threshold Voltage vs Temperature

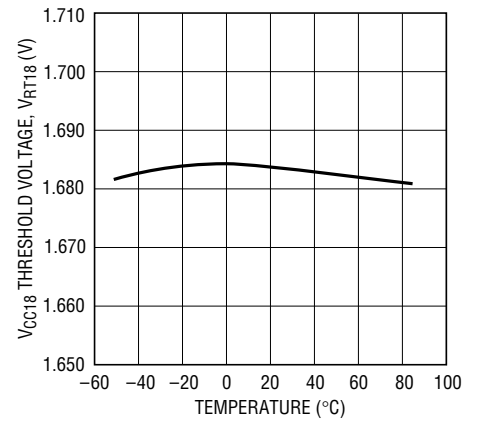

1985-18 G06

Typical Transient Duration vs Comparator Overdrive

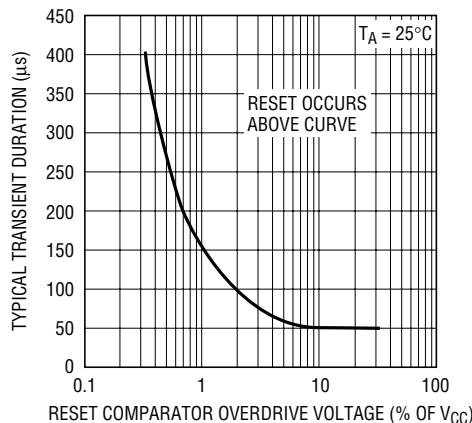

1985-18 G07

Reset Pulse Width vs Temperature

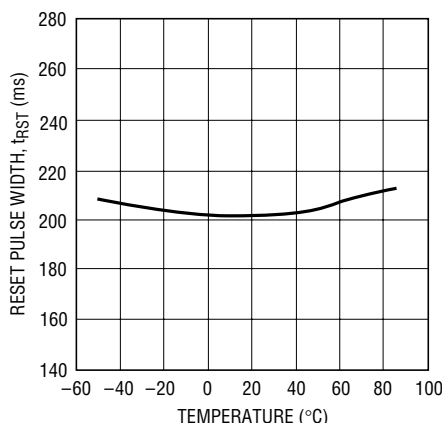

1985-18 G08

I_{SINK} vs Supply Voltage

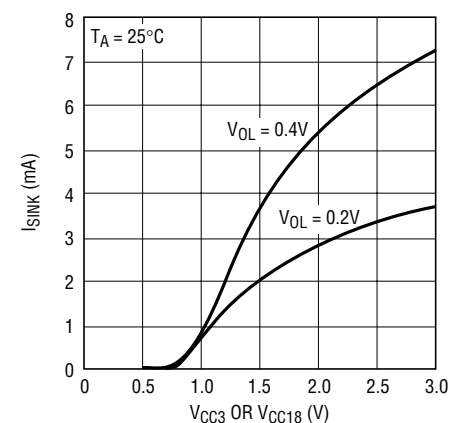

1985-18 • G09

TYPICAL PERFORMANCE CHARACTERISTICS

RST High Level Output Voltage vs Output Source Current

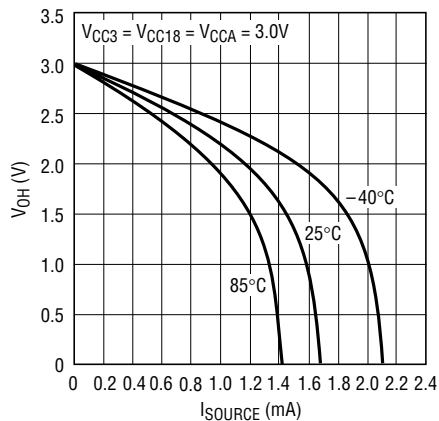

RST Voltage Output Low vs Output Sink Current

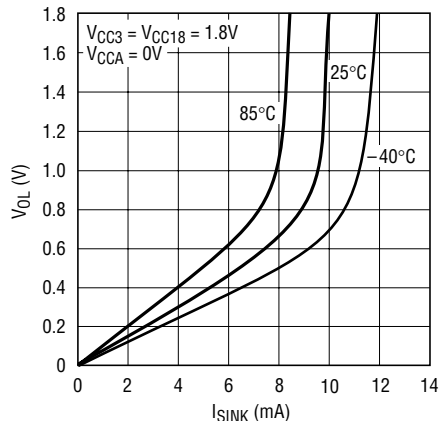

RST Voltage Output Low vs Output Sink Current

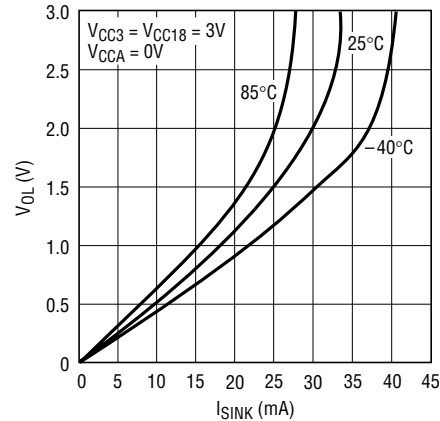

PIN FUNCTIONS

RST (Pin 1): Reset Logic Output. Active low, 3V push-pull output. Asserted when one or all of the supplies are below trip thresholds and held for 200ms after all supplies become valid.

GND (Pin 2): Ground.

V_{CCA} (Pin 3): 1V Sense, High Impedance Input. If unused it can be tied to either V_{CC3} or V_{CC18}.

V_{CC18} (Pin 4): 1.8V Sense Input and Power Supply Pin. This pin is used on the LTC1985 to provide power to the part when the voltage on V_{CC18} is greater than the voltage on V_{CC3}. Bypass to ground with a $\geq 0.1\mu F$ ceramic capacitor.

V_{CC3} (Pin 5): 3V Sense Input and Power Supply Pin. This pin provides power to the part when the voltage on V_{CC3} is greater than the voltage on V_{CC18}. Bypass to ground with a $\geq 0.1\mu F$ ceramic capacitor.

BLOCK DIAGRAM

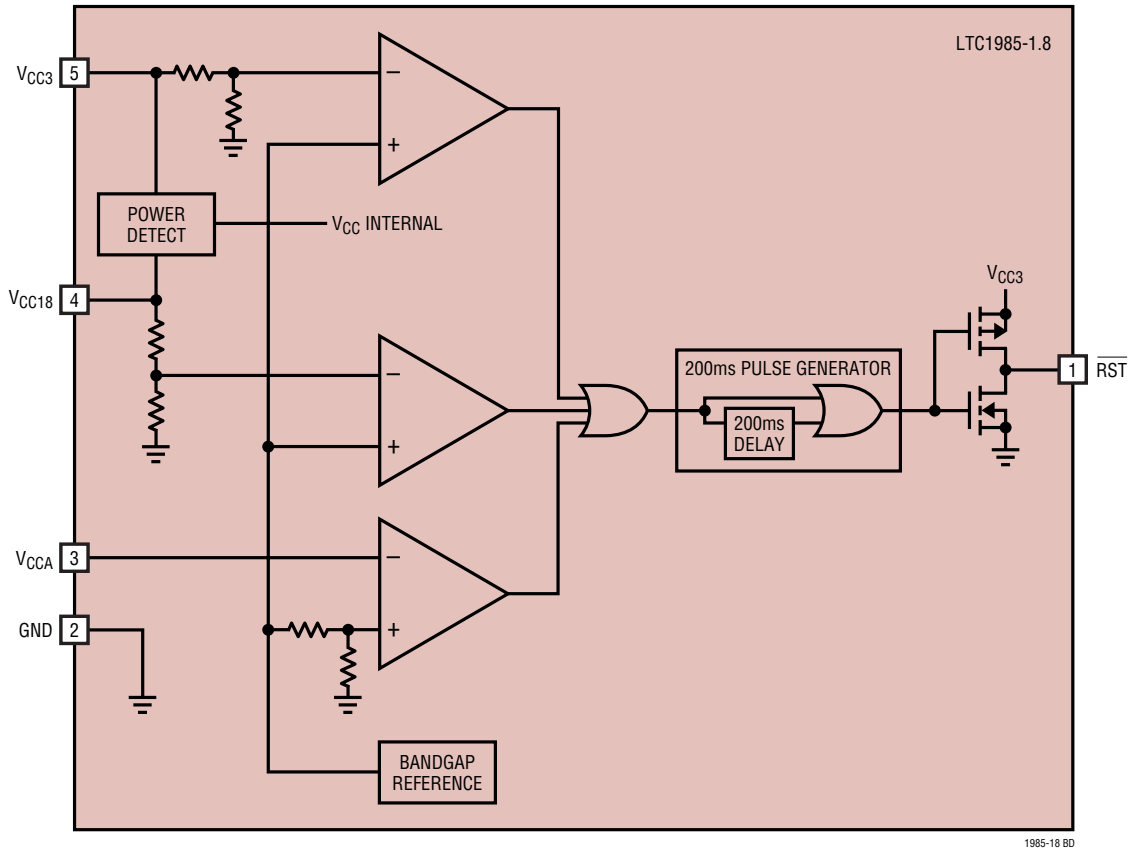

1985-18 BD

TIMING DIAGRAM

VCC Monitor Timing

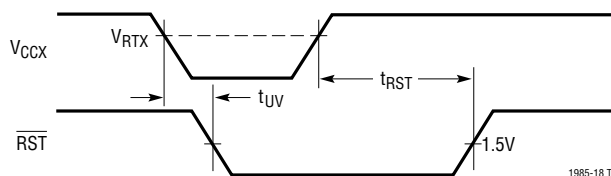

1985-18 TD

APPLICATIONS INFORMATION

Supply Monitoring

The LTC1985 is a low power, high accuracy triple supply monitoring circuit with a single 200ms microprocessor reset output.

All three V_{CC} inputs must be above predetermined thresholds for reset not to be invoked. The LTC1985 will assert reset during power-up, power-down and brownout conditions on any one or all of the V_{CC} inputs.

3V or 1.8V Power Detect

The LTC1985 is powered from the 3V input pin (V_{CC3}) or the 1.8V input pin (V_{CC18}), whichever pin has the highest potential. This ensures the part pulls the \overline{RST} pin low as soon as either input pin is $\geq 1V$.

Power-Up

Upon power-up, either the V_{CC18} or V_{CC3} pin, can power the part. This ensures that \overline{RST} will be low when either V_{CC18} or V_{CC3} reaches 1V. As long as any one of the V_{CC} inputs is below its predetermined threshold, \overline{RST} will stay a logic low. Once all of the V_{CC} inputs rise above their thresholds, an internal timer is started and \overline{RST} is driven high after 200ms.

\overline{RST} is reasserted whenever any one of the V_{CC} inputs drops below its predetermined threshold and remains asserted until 200ms after all of the V_{CC} inputs are above their thresholds.

Power-Down

On power-down, once any of the V_{CC} inputs drop below its threshold, \overline{RST} is held at a logic low. A logic low of 0.3V is guaranteed until both V_{CC3} and V_{CC18} drop below 1V.

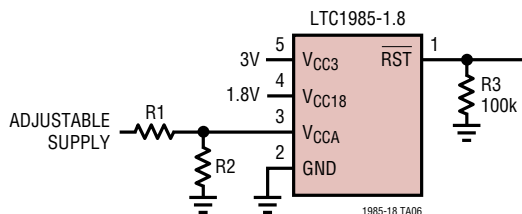

Figure 1. Typical Application Showing Resistor on \overline{RST} Output to Ground

Override Functions

The V_{CCA} pin, if unused, can be tied to either V_{CC3} or V_{CC18} . This is an obvious solution since the trip points for V_{CC3} and V_{CC18} will always be greater than the trip point for V_{CCA} . Likewise, the V_{CC18} , if unused, can be tied to V_{CC3} . V_{CC3} must always be used. Tying V_{CC3} to V_{CC18} and operating off of a 1.8V supply will result in the continuous assertion of \overline{RST} .

Ensuring \overline{RST} Valid for Supply Voltages Under 1V

When the supplies drops below 1V the \overline{RST} output current sink capability is drastically reduced. The combination of stray currents and stray capacitance to signals other than ground can cause the \overline{RST} output pin to float around. In a lot of applications this is not a problem since most microprocessors and other circuits do not operate with the supply voltage less than 1V. In applications where the \overline{RST} output must be valid down to 0V the addition of a pull-down resistor from \overline{RST} to ground will ensure \overline{RST} is held low. The circuit in Figure 1 shows an application employing this technique. The value chosen for the pull-down resistor ($R3$) is a trade-off between pull-down strength and loading of the \overline{RST} pin. If the value of the resistor is too large the pin may still float and if the resistor value is too low it may load down the \overline{RST} as well as burn excess supply current, a value of 100k is a good compromise.

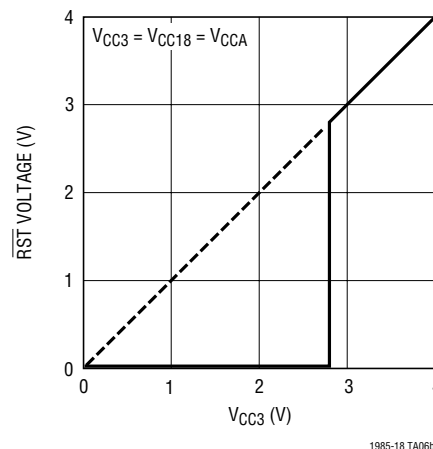
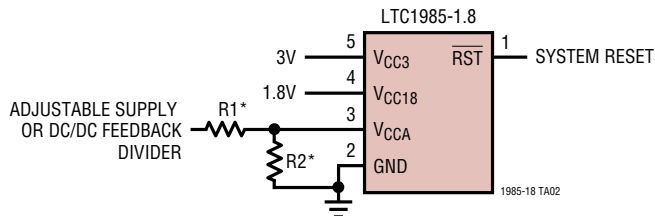

Figure 2. \overline{RST} Voltage vs V_{CC3} with a 100k Resistor on \overline{RST} to Ground

TYPICAL APPLICATIONS

Triple Supply Monitor (3V, 1.8V and Adjustable)



*TO PRESERVE THRESHOLD ACCURACY, SET PARALLEL COMBINATION OF R1 AND R2 $\leq 66.5k$

Dual Supply Monitor (3V and 1.8V, Defeat V_{CCA} Input)

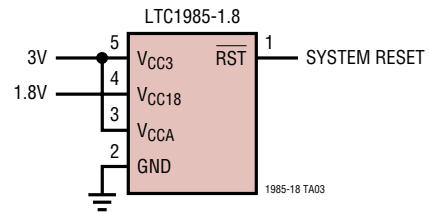

Dual Supply Monitor (3V Plus Adjustable)

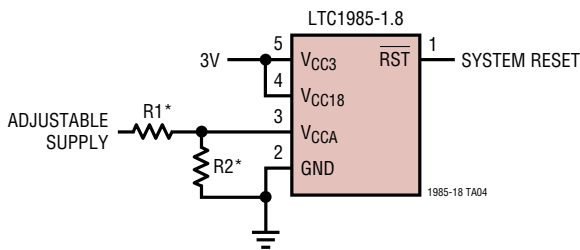

*TO PRESERVE THRESHOLD ACCURACY, SET PARALLEL COMBINATION OF R1 AND R2 $\leq 66.5k$

Using V_{CCA} Tied to DC/DC Feedback Divider

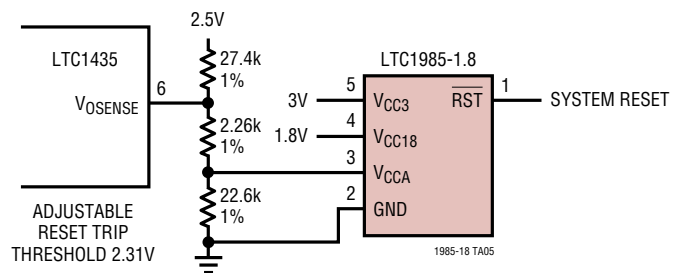

TYPICAL APPLICATION

Triple Supply Monitor with Manual Reset Button

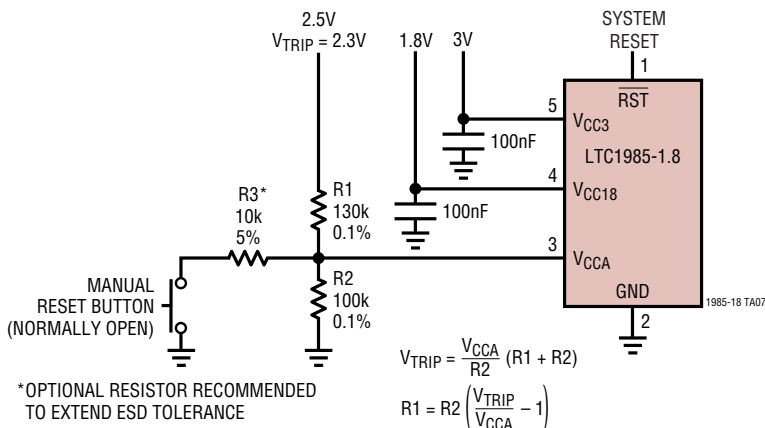

PACKAGE DESCRIPTION

Dimensions in inches (millimeters) unless otherwise noted.

S5 Package 5-Lead Plastic SOT-23 (LTC DWG # 05-08-1633)

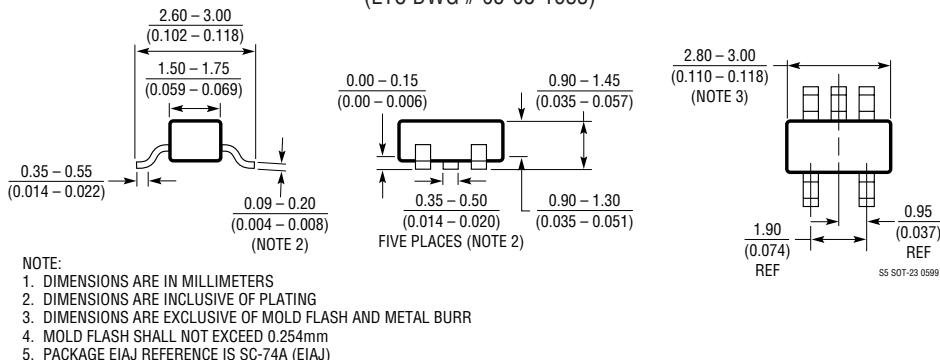

RELATED PARTS

PART NUMBER	DESCRIPTION	COMMENTS
LTC690	5V Supply Monitor, Watchdog Timer and Battery Backup	4.65V Threshold
LTC694-3.3	3.3V Supply Monitor, Watchdog Timer and Battery Backup	2.9V Threshold
LTC699	5V Supply Monitor and Watchdog Timer	4.65V Threshold
LTC1232	5V Supply Monitor, Watchdog Timer and Push-Button Reset	4.37V/4.62V Threshold
LTC1326	Micropower Precision Triple Supply Monitor for 5V, 3.3V and ADJ	4.725V, 3.118V, 1V Thresholds (±0.75%)
LTC1326-2.5	Micropower Precision Triple Supply Monitor for 2.5V, 3.3V and ADJ	2.363V, 3.118V, 1V Thresholds (±0.75%)
LTC1536	Precision Triple Supply Monitor for PCI Applications	Meets PCI t _{FAIL} Timing Specifications
LTC1726-2.5	Micropower Triple Supply Monitor for 2.5V, 3.3V and ADJ	Adjustable $\overline{\text{RESET}}$ and Watchdog Time Outs
LTC1726-5	Micropower Triple Supply Monitor for 5V, 3.3V and ADJ	Adjustable $\overline{\text{RESET}}$ and Watchdog Time Outs
LTC1727-2.5/1727-5	Micropower Triple Supply Monitor with Open-Drain Reset	Individual Monitor Outputs in MSOP
LTC1728-1.8	Micropower Triple Supply Monitor with Open-Drain Reset	5-Lead SOT-23 Package
LTC1728-2.5/1728-5	Micropower Triple Supply Monitor with Open-Drain Reset	5-Lead SOT-23 Package