

# TPS54062 4.7-V to 60-V Input, 50-mA Synchronous Step-Down Converter With Low IQ

## 1 Features

- Integrated High-Side and Low-Side MOSFET
- Peak Current Mode Control
- Diode Emulation for Improved Light-Load Efficiency
- 89  $\mu$ A (typical) Operating Quiescent Current
- 100-kHz to 400-kHz Adjustable Switching Frequency
- Synchronizes to External Clock
- Internal Slow-Start
- 0.8 V  $\pm$ 2% Voltage Reference
- Stable with Ceramic Output Capacitors or Low-Cost Aluminum Electrolytic
- Cycle-by-Cycle Current Limit, Thermal and Frequency Foldback Protection
- MSOP-8 and 3mm x 3mm VSON-8 Packages

## 2 Applications

- Low-Power Standby or Bias Voltage Supplies
- 4-20 mA Current-Loop Powered Sensors
- Industrial Process Control, Metering, and Security Systems
- High Voltage Linear Regulator Replacement

## 3 Description

The TPS54062 device is a 60-V, 50-mA, synchronous step-down converter with integrated high-side and low-side MOSFETs. Current mode control provides simple external compensation and flexible component selection. The non-switching supply current is 89  $\mu$ A. Using the enable pin, shutdown supply current is reduced to 1.7  $\mu$ A.

Undervoltage lockout is internally set at 4.5 V, but can be increased using the accurate enable pin threshold. The output voltage start-up ramp is controlled by the internal slow-start time.

Adjustable switching frequency range allows efficiency and external component size to be optimized. Frequency foldback and thermal shutdown protects the part during an overload condition.

### Device Information<sup>(1)</sup>

PART NUMBER	PACKAGE	BODY SIZE (NOM)
TPS54062	MSOP (8)	3.00 mm x 3.00 mm
	VSON (8)	

(1) For all available packages, see the orderable addendum at the end of the datasheet.

### Simplified Schematic

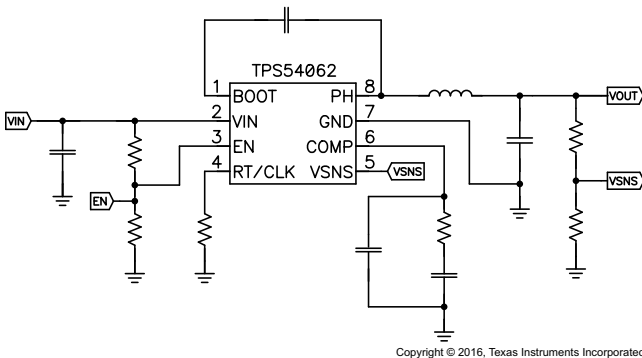

### Efficiency

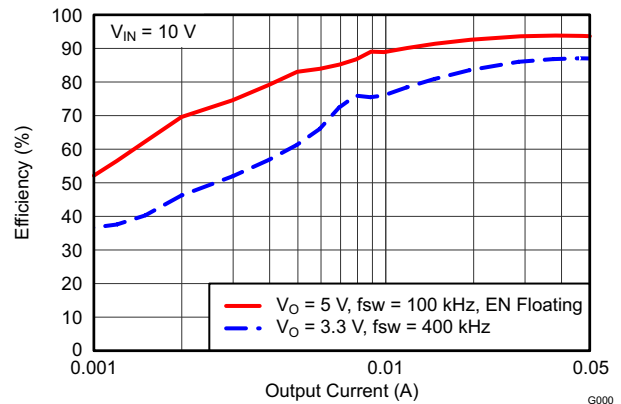

## Table of Contents

<b>1 Features</b> .....	<b>1</b>	7.4 Device Functional Modes.....	<b>16</b>
<b>2 Applications</b> .....	<b>1</b>	<b>8 Applications and Implementation</b> .....	<b>17</b>
<b>3 Description</b> .....	<b>1</b>	8.1 Application Information.....	<b>17</b>
<b>4 Revision History</b> .....	<b>2</b>	8.2 Typical Applications .....	<b>17</b>
<b>5 Pin Configuration and Functions</b> .....	<b>4</b>	<b>9 Power Supply Recommendations</b> .....	<b>31</b>
<b>6 Specifications</b> .....	<b>5</b>	<b>10 Layout</b> .....	<b>31</b>
6.1 Absolute Maximum Ratings .....	<b>5</b>	10.1 Layout Guidelines .....	<b>31</b>
6.2 ESD Ratings.....	<b>5</b>	10.2 Layout Example .....	<b>31</b>
6.3 Recommended Operating Conditions.....	<b>5</b>	<b>11 Device and Documentation Support</b> .....	<b>32</b>
6.4 Thermal Information .....	<b>6</b>	11.1 Receiving Notification of Documentation Updates	<b>32</b>
6.5 Electrical Characteristics.....	<b>6</b>	11.2 Community Resources.....	<b>32</b>
6.6 Typical Characteristics.....	<b>8</b>	11.3 Trademarks .....	<b>32</b>
<b>7 Detailed Description</b> .....	<b>11</b>	11.4 Electrostatic Discharge Caution.....	<b>32</b>
7.1 Overview .....	<b>11</b>	11.5 Glossary .....	<b>32</b>
7.2 Functional Block Diagram .....	<b>12</b>	<b>12 Mechanical, Packaging, and Orderable</b>	<b>32</b>
7.3 Feature Description.....	<b>12</b>	<b>Information</b> .....	<b>32</b>

## 4 Revision History

<b>Changes from Revision C (December 2014) to Revision D</b>	<b>Page</b>
• Added text to the <a href="#">Layout Guidelines</a> section " All sensitive analog traces and components..." .....	<b>31</b>

<b>Changes from Revision B (August 2012) to Revision C</b>	<b>Page</b>
• Added <i>Handling Rating</i> table, <i>Feature Description</i> section, <i>Device Functional Modes</i> , <i>Application and Implementation</i> section, <i>Power Supply Recommendations</i> section, <i>Layout</i> section, <i>Device and Documentation Support</i> section, and <i>Mechanical, Packaging, and Orderable Information</i> section. ....	<b>1</b>

<b>Changes from Revision A (October 2011) to Revision B</b>	<b>Page</b>
• Added features Item: Diode Emulation for Improved Light-Load Efficiency .....	<b>1</b>
• Changed Features Item From: 100 kHz to 400 kHz Switching Frequency To: 100 kHz to 400 kHz Adjustable Switching Frequency .....	<b>1</b>
• Changed the Efficiency Graph.....	<b>1</b>
• Changed VSON-8 package graphic to clarify ThermalPAD area.....	<b>4</b>
• Changed the EN pin MAX value From: 5 V To: 8 V .....	<b>5</b>
• Changed the Enable and Adjusting Undervoltage Lockout section .....	<b>13</b>
• Changed <a href="#">Equation 22</a> through <a href="#">Equation 25</a> .....	<b>21</b>

**Changes from Original (May 2011) to Revision A**
**Page**

• Changed Features Item From: MSOP8 and WSON8 Packages To: MSOP-8 and 3 mm x 3 mm VSON-8 Packages.....	1
• Changed the Efficiency Graph.....	1
• Added the VSON (DRB-8 Pin) Package .....	4
• Changed the RT/CLK pin Description .....	4
• Added VSON-8 Pins values to the Thermal Information table .....	6
• Changed the PLL lock in time Unit of Measure From: $\mu$ A To: $\mu$ s.....	7
• Changed <a href="#">Equation 22</a> .....	21
• Changed the Efficiency vs Output Current Graphs, <a href="#">Figure 21</a> and <a href="#">Figure 22</a> .....	22

---

## 5 Pin Configuration and Functions

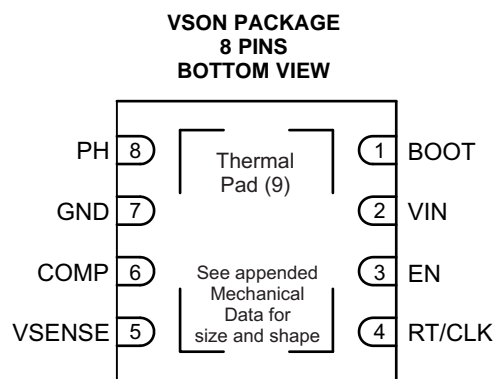
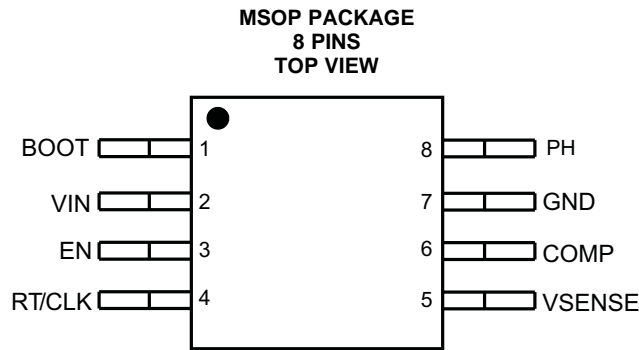

### Pin Functions

PIN		I/O	DESCRIPTION
NAME	NUMBER		
BOOT	1	O	A bootstrap capacitor is required between BOOT and PH. If the voltage on this capacitor is below the minimum required by the output device, the output is forced to switch off until the capacitor is refreshed.
VIN	2	I	Input supply voltage, 4.7 V to 60 V.
EN	3	I	Enable pin, internal pull-up current source. Pull below 1.14 V to disable. Float to enable. Adjust the input undervoltage lockout with two resistors, see the <a href="#">Enable and Adjusting Undervoltage Lockout</a> section.
RT/CLK	4	I	Resistor Timing and External Clock. An internal amplifier holds this pin at a fixed voltage when using an external resistor to ground to set the switching frequency. If the pin is pulled above the PLL upper threshold, a mode change occurs and the pin becomes a synchronization input. The internal amplifier is disabled and the pin is a high impedance clock input to the internal PLL. If clocking edges stop, the internal amplifier is re-enabled and the mode returns to a resistor frequency programming.
VSENSE	5	I	Inverting input of the transconductance (gm) error amplifier.
COMP	6	O	Error amplifier output, and input to the output switch current comparator. Connect frequency compensation components to this pin.
GND	7	–	Ground
PH	8	O	The source of the internal high-side power MOSFET and drain of the internal low side MOSFET
Thermal Pad	9	–	GND pin must be electrically connected to the exposed pad on the printed circuit board for proper operation. VSON-8 package only.

## 6 Specifications

### 6.1 Absolute Maximum Ratings<sup>(1)</sup>

over operating free-air temperature range (unless otherwise noted)

		MIN	MAX	UNIT
Voltage	VIN	-0.3	62	V
	EN	-0.3	8	V
	BOOT-PH	-0.3	8	V
	VSENSE	-0.3	6	V
	COMP	-0.3	3	V
	PH	-0.6	62	V
	PH, 10ns Transient	-2	62	V
	RT/CLK	-0.3	6	V
Current	VIN	Internally Limited		A
	EN	100		μA
	BOOT	100		mA
	VSENSE	10		μA
	COMP	100		μA
	PH	Internally Limited		A
	RT/CLK	200		μA
Operating junction temperature		-40	125	°C
Storage temperature, T <sub>sg</sub>		-65	150	°C

(1) The Absolute Maximum Ratings specified in this section will apply to all specifications of this document unless otherwise noted. These specifications will be interpreted as the conditions which may damage the device with a single occurrence.

### 6.2 ESD Ratings

		VALUE	UNIT
V <sub>(ESD)</sub> Electrostatic discharge	Human-body model (HBM), per ANSI/ESDA/JEDEC JS-001 <sup>(1)</sup>	±2000	V
	Charged-device model (CDM), per JEDEC specification JESD22-C101 <sup>(2)</sup>	±500	

(1) JEDEC document JEP155 states that 500-V HBM allows safe manufacturing with a standard ESD control process.

(2) JEDEC document JEP157 states that 250-V CDM allows safe manufacturing with a standard ESD control process.

### 6.3 Recommended Operating Conditions

over operating free-air temperature range (unless otherwise noted)

	MIN	MAX	UNIT
Input voltage	4.7	60	V
Output current		50	mA
Switching frequency set by RT/CLK resistor	100	400	kHz
Switching frequency synchronized to external clock	300	400	kHz

## 6.4 Thermal Information

THERMAL METRIC <sup>(1)</sup>		TPS54062		UNIT
		MSOP	VSON	
		8 PINS	8 PINS	
R <sub>θJA</sub>	Junction-to-ambient thermal resistance	127.1	40.2	°C/W
R <sub>θJC(top)</sub>	Junction-to-case (top) thermal resistance	33.4	49.7	
R <sub>θJB</sub>	Junction-to-board thermal resistance	80	15.7	
ψ <sub>JT</sub>	Junction-to-top characterization parameter	1	0.6	
ψ <sub>JB</sub>	Junction-to-board characterization parameter	79	15.9	
R <sub>θJC(bot)</sub>	Junction-to-case (bottom) thermal resistance	N/A	4.1	

(1) For more information about traditional and new thermal metrics, see the [Semiconductor and IC Package Thermal Metrics](#) application report.

## 6.5 Electrical Characteristics<sup>(1)</sup>

T<sub>J</sub> = -40°C to 125°C, VIN = 4.7 to 60 V (unless otherwise noted)

PARAMETER	CONDITIONS	MIN	TYP	MAX	UNIT
<b>SUPPLY VOLTAGE (VIN PIN)</b>					
Operating input voltage	VIN	4.7		60	V
Shutdown supply current	EN = 0 V		1.7		μA
Iq Operating – Non-switching	VSENSE = 0.9 V, VIN = 12 V		89	110	μA
<b>ENABLE AND UVLO (EN PIN)</b>					
Enable threshold	Rising		1.24	1.4	V
	Falling	1	1.14		V
Input current	Enable threshold +50 mV		-4.7		μA
	Enable threshold -50 mV		-1.2		μA
Hysteresis			3.5		μA
Enable to start switching time			450		μs
<b>VIN</b>					
VIN start voltage	VIN rising		4.53		V
<b>VOLTAGE REFERENCE</b>					
Voltage reference	1mA < I <sub>OUT</sub> < Minimum Current Limit	0.784	0.8	0.816	V
<b>HIGH-SIDE MOSFET</b>					
Switch resistance	BOOT-PH = 5.7 V		1.5	2.8	Ω
<b>LOW-SIDE MOSFET</b>					
Switch resistance	VIN = 12 V		0.8	1.5	Ω
<b>ERROR AMPLIFIER</b>					
Input Current	VSENSE pin		20		nA
Error amp gm	-2 μA < I <sub>(COMP)</sub> < 2 μA, V <sub>(COMP)</sub> = 1 V		102		μS
EA gm during slow-start	-2 μA < I <sub>(COMP)</sub> < 2 μA, V <sub>(COMP)</sub> = 1 V, VSENSE = 0.4 V		26		μS
Error amp DC gain	VSENSE = 0.8 V		1000		V/V
Min unity gain bandwidth			0.5		MHz
Error amp source/sink	V <sub>(COMP)</sub> = 1 V, 100-mV Overdrive		±8		μA
Start Switching Threshold			0.57		V
COMP to Iswitch gm			0.65		A/V
<b>CURRENT LIMIT</b>					
High-side sourcing current limit threshold	VIN = 12V, BOOT-PH = 5.7 V	75	134		mA
Zero cross detect current			-0.7		mA

(1) The Electrical Ratings specified in this section will apply to all specifications in this document unless otherwise noted. These specifications will be interpreted as conditions that will not degrade the device's parametric or functional specifications for the life of the product containing it.

**Electrical Characteristics<sup>(1)</sup> (continued)**
 $T_J = -40^{\circ}\text{C}$  to  $125^{\circ}\text{C}$ ,  $V_{IN} = 4.7$  to  $60$  V (unless otherwise noted)

PARAMETER	CONDITIONS	MIN	TYP	MAX	UNIT
<b>THERMAL SHUTDOWN</b>					
Thermal shutdown			146		C
<b>RT/CLK</b>					
Operating frequency using RT mode		100		400	kHz
Switching frequency	$R_{(RT/CLK)} = 510\text{ k}\Omega$	192	240	288	kHz
Minimum CLK pulse width			40		ns
RT/CLK voltage	$R_{(RT/CLK)} = 510\text{ k}\Omega$		0.53		V
RT/CLK high threshold				1.3	V
RT/CLK low threshold		0.5			V
RT/CLK falling edge to PH rising edge delay	Measure at 240 kHz with RT resistor in series		100	200	ns
PLL lock in time	Measure at 240 kHz		100		$\mu\text{s}$
PLL frequency range		300		400	kHz
<b>PH</b>					
Minimum On-time	Measured at 50% to 50% of $V_{IN}$ $I_{OUT} = 50\text{ mA}$		120		ns
Dead time	$V_{IN} = 12\text{ V}$ , $I_{OUT} = 50\text{ mA}$ , One transition		30		ns
<b>BOOT</b>					
BOOT-PH regulation voltage	$V_{IN} = 12\text{ V}$		5.7		V
BOOT-PH UVLO			2.9		V
<b>INTERNAL SLOW-START TIME</b>					
Slow-start time	$f_{SW} = 240\text{ kHz}$ , $RT = 510\text{ k}\Omega$ , 10% to 90%		4.1		ms

## 6.6 Typical Characteristics

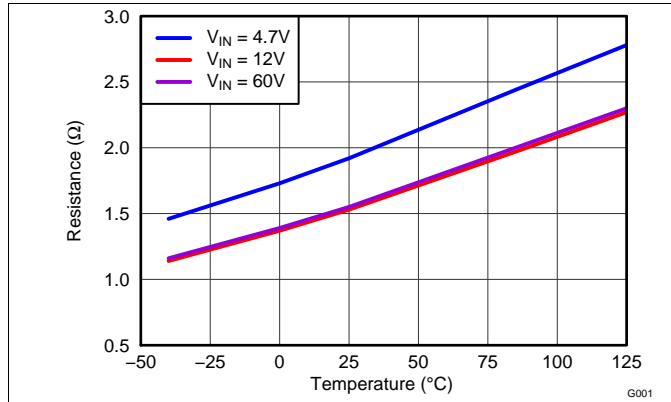

Figure 1. High-Side  $R_{DS(on)}$  vs Temperature

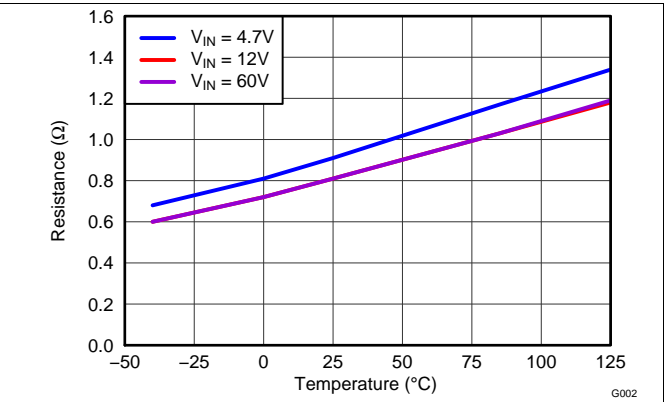

Figure 2. Low-Side  $R_{DS(on)}$  vs Temperature

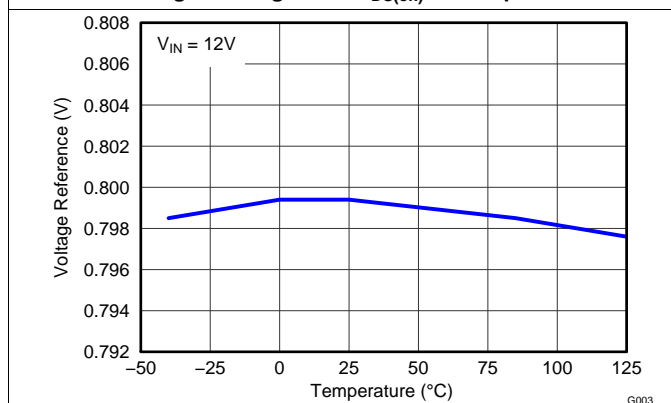

Figure 3.  $V_{REF}$  Voltage vs Temperature

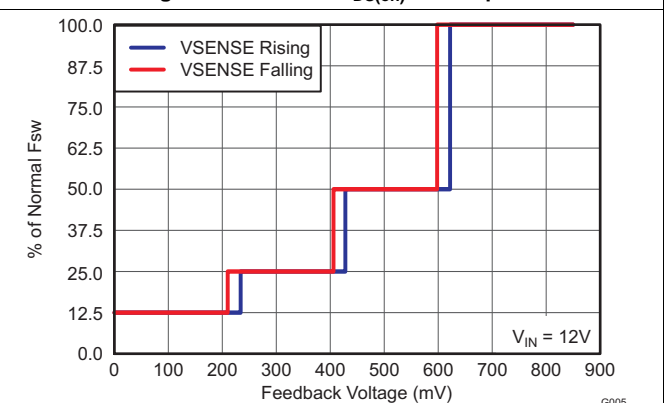

Figure 4. Frequency vs  $V_{SENSE}$  Voltage

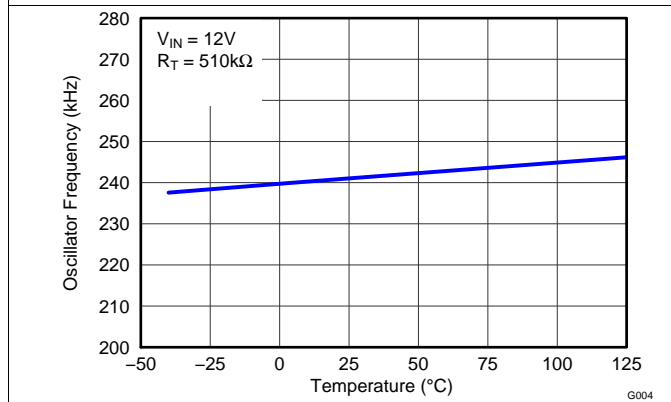

Figure 5. Frequency vs Temperature

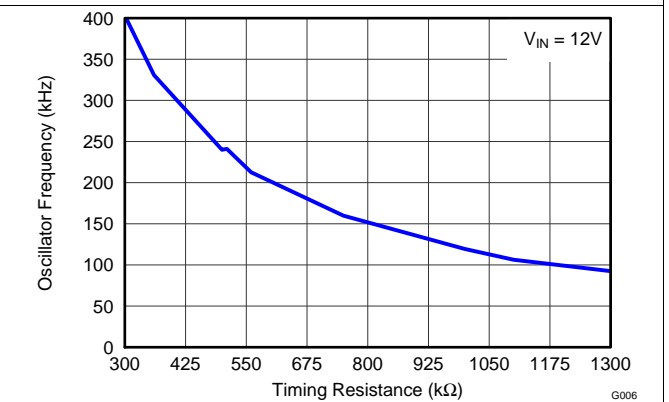

Figure 6. Frequency vs  $R_T/CLK$  Resistance



Typical Characteristics (continued)

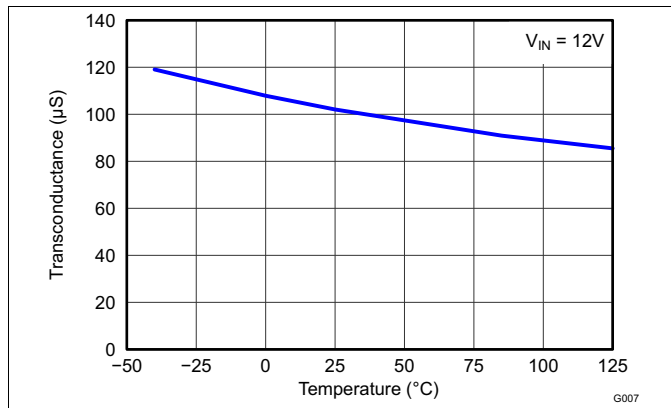

Figure 7. Error Amp Transconductance vs Temperature

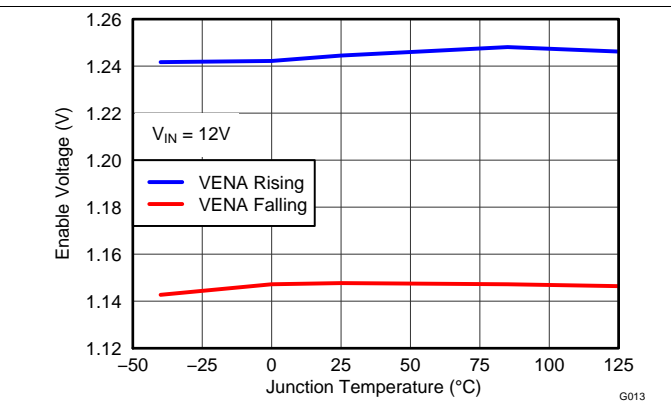

Figure 8. Enable Pin Voltage vs Temperature

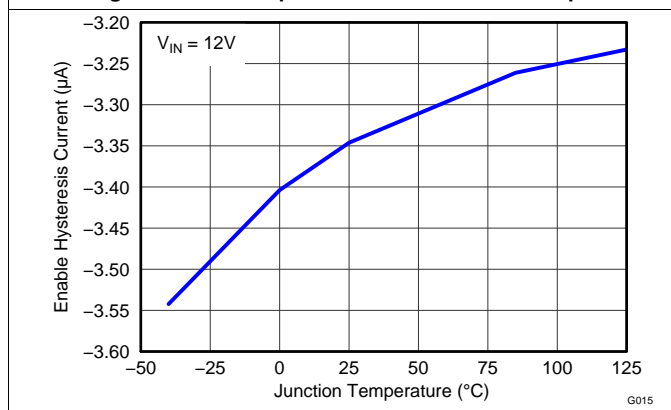

Figure 9. Enable Pin Hysteresis Current vs Temperature

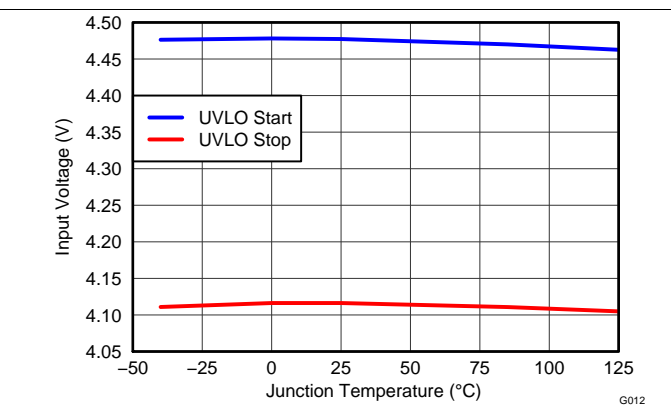

Figure 10. Input Voltage (UVLO) vs Temperature

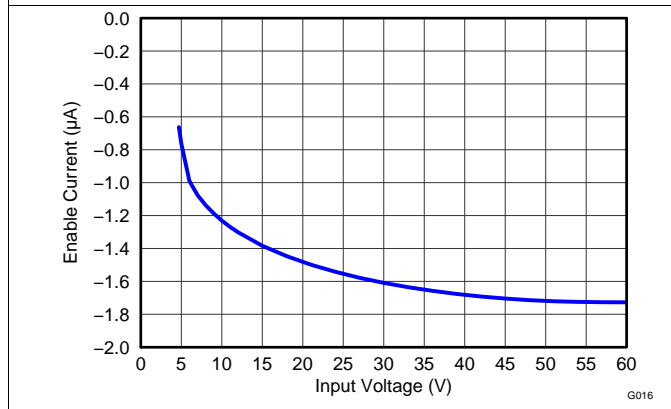

Figure 11. Enable Pin Pullup Current vs Input Voltage

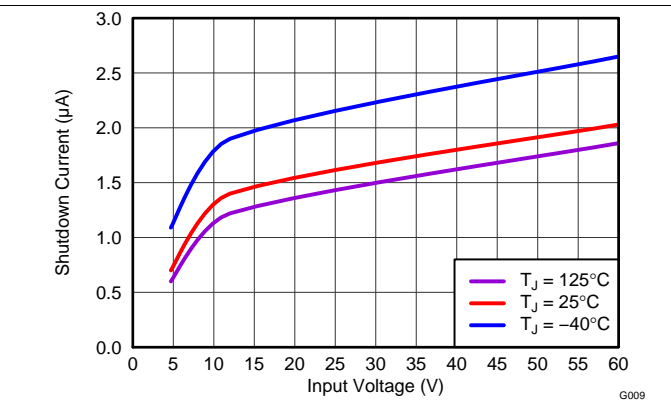

Figure 12. Shutdown Supply Current (VIN) vs Input Voltage

Typical Characteristics (continued)

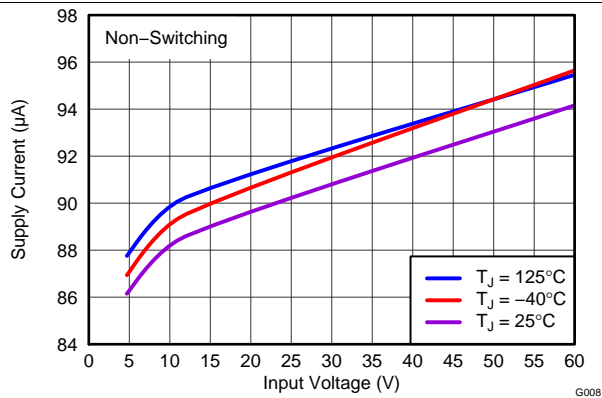

Figure 13. Supply Current (VIN pin) vs Input Voltage

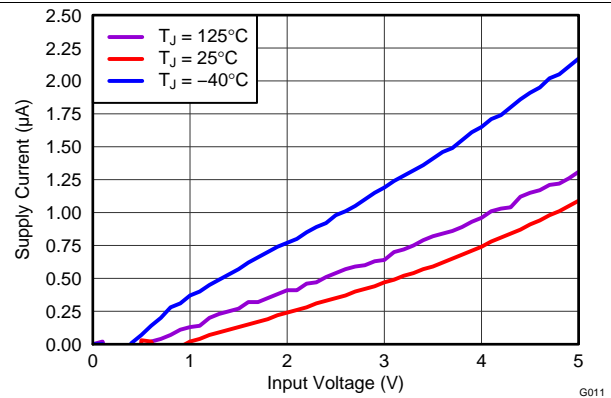

Figure 14. Supply Current (VIN pin) vs Input Voltage (0V to VSTART) EN Pin Low

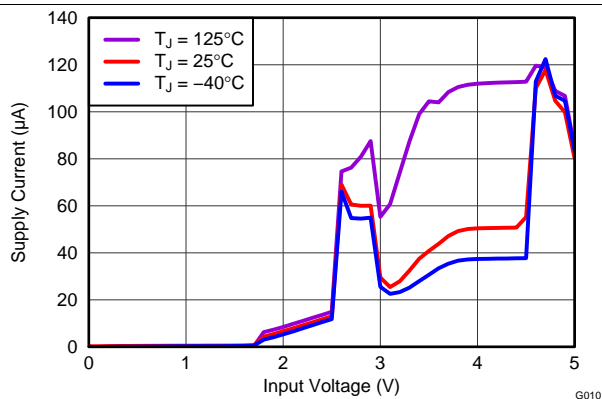

Figure 15. Supply Current (VIN pin) vs Input Voltage (0V to VSTART) EN Pin Open

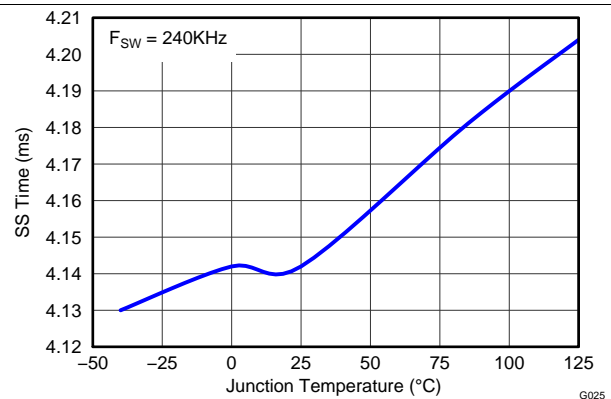

Figure 16. Slow-Start Time vs Temperature

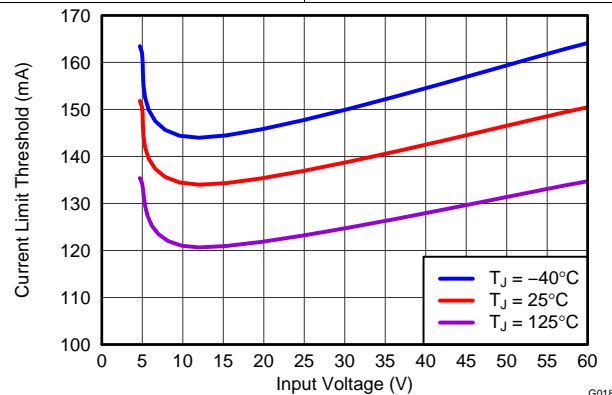

Figure 17. Current Limit vs Input Voltage

## 7 Detailed Description

### 7.1 Overview

The TPS54062 device is a 60-V, 50-mA, step-down (buck) regulator with an integrated high-side and low-side n-channel MOSFET. To improve performance during line and load transients the device implements a constant-frequency, current mode control, which reduces output capacitance and simplifies external frequency compensation design.

The switching frequency of 100 kHz to 400 kHz allows for efficiency and size optimization when selecting the output filter components. The switching frequency is adjusted using a resistor-to-ground on the RT/CLK pin. The device has an internal phase lock loop (PLL) on the RT/CLK pin that is used to synchronize the power switch turn on to a falling edge of an external system clock.

The TPS54062 has a default start-up voltage of approximately 4.5 V. The EN pin has an internal pullup current source that can be used to adjust the input voltage undervoltage lockout (UVLO) threshold with two external resistors. In addition, the pullup current provides a default condition. When the EN pin is floating the device will operate. The operating current is 89  $\mu$ A when not switching and under no load. When the device is disabled, the supply current is 1.7  $\mu$ A.

The integrated 1.5- $\Omega$  high-side MOSFET and 0.8- $\Omega$  low-side MOSFET allows for high efficiency power supply designs capable of delivering 50-mA of continuous current to a load.

The TPS54062 reduces the external component count by integrating the boot recharge diode. The bias voltage for the integrated high-side MOSFET is supplied by a capacitor on the BOOT to PH pin. The boot capacitor voltage is monitored by an UVLO circuit and will turn the high-side MOSFET off when the boot voltage falls below a preset threshold. The TPS54062 can operate at high duty cycles because of the boot UVLO. The output voltage can be stepped down to as low as the 0.8-V reference.

The TPS54062 has an internal output OV protection that disables the high-side MOSFET if the output voltage is 109% of the nominal output voltage.

The TPS54062 reduces external component count by integrating the slow-start time using a reference DAC system.

The TPS54062 resets the slow-start times during overload conditions with an overload recovery circuit. The overload recovery circuit will slow start the output from the fault voltage to the nominal regulation voltage once a fault condition is removed. A frequency foldback circuit reduces the switching frequency during start-up and overcurrent fault conditions to help control the inductor current.

## 7.2 Functional Block Diagram

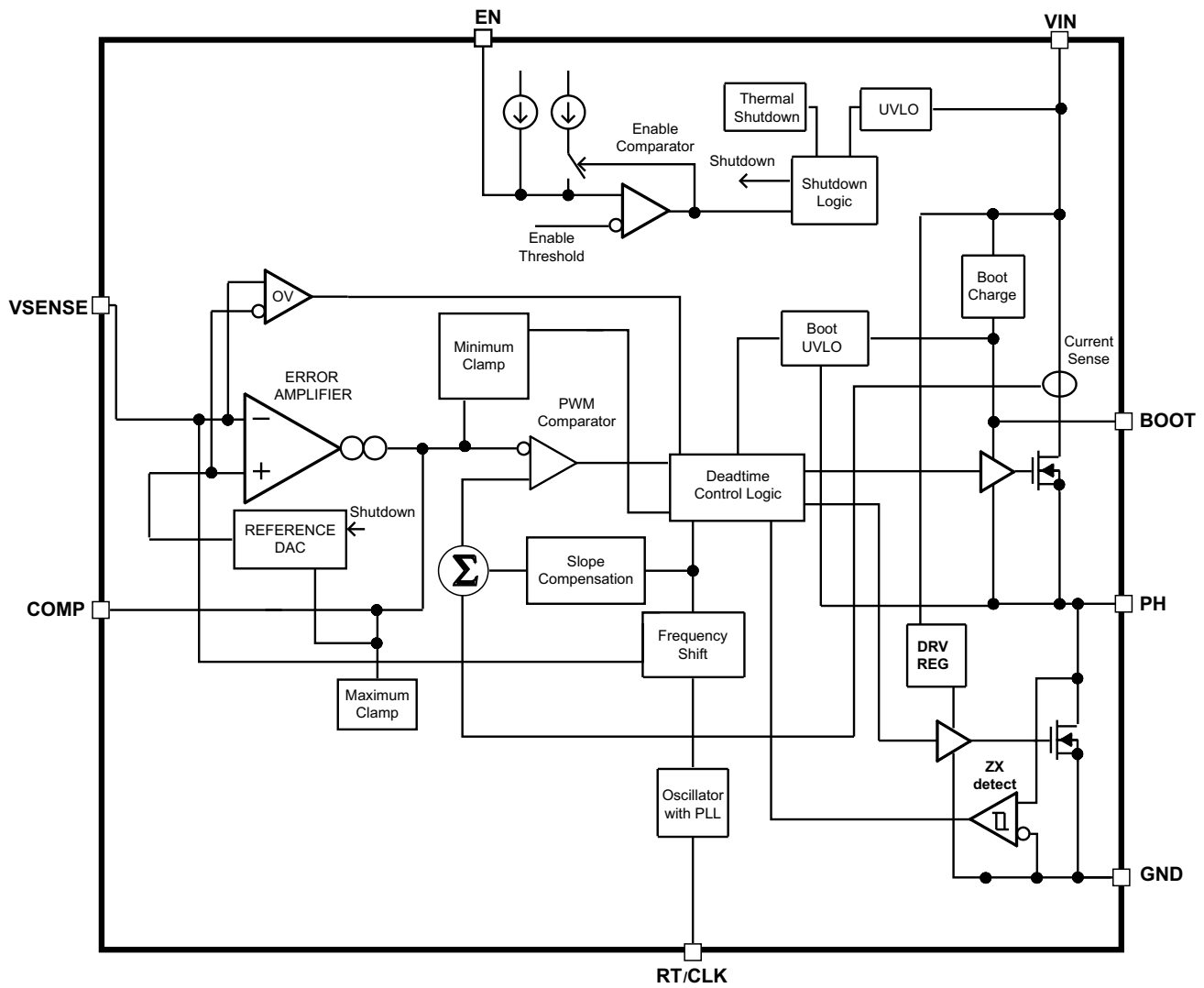

Copyright © 2016, Texas Instruments Incorporated

## 7.3 Feature Description

### 7.3.1 Fixed-Frequency PWM Control

The TPS54062 uses an adjustable fixed-frequency, peak current mode control. The output voltage is compared through external resistors on the VSENSE pin to an internal voltage reference by an error amplifier which drives the COMP pin. An internal oscillator initiates the turn on of the high-side power switch. The error amplifier output is compared to the high-side power switch current. When the power switch current reaches the level set by the COMP voltage, the power switch is turned off. The COMP pin voltage will increase and decrease as the output current increases and decreases. The device implements a current limit by clamping the COMP pin voltage to a maximum level.

### 7.3.2 Slope Compensation Output Current

The TPS54062 adds a compensating ramp to the switch current signal. This slope compensation prevents sub-harmonic oscillations.

## Feature Description (continued)

### 7.3.3 Error Amplifier

The TPS54062 has a transconductance amplifier for the error amplifier. The error amplifier compares the VSENSE voltage to the lower of the internal slow-start voltage or the internal 0.8-V voltage reference. The transconductance (gm) of the error amplifier is 102 μS during normal operation. During the slow-start operation, the transconductance is a fraction of the normal operating gm. The frequency compensation components (capacitor, series resistor and capacitor) are added to the COMP pin-to-ground.

### 7.3.4 Voltage Reference

The voltage reference system produces a precise ±2 voltage reference over temperature by scaling the output of a temperature stable band-gap circuit

### 7.3.5 Adjusting the Output Voltage

The output voltage is set with a resistor divider from the output node to the VSENSE pin. TI recommends using 1% tolerance or better divider resistors. Start with a 10-kΩ for the R<sub>LS</sub> resistor and use the [Equation 1](#) to calculate R<sub>HS</sub>.

$$R_{HS} = R_{LS} \times \left( \frac{V_{OUT} - 0.8 \text{ V}}{0.8 \text{ V}} \right) \quad (1)$$

### 7.3.6 Enable and Adjusting Undervoltage Lockout

The TPS54062 is enabled when the VIN pin voltage rises above 4.53 V and the EN pin voltage exceeds the EN rising threshold of 1.24 V. The EN pin has an internal pullup current source, I<sub>1</sub>, of 1.2 μA that provides the default enabled condition when the EN pin floats.

If an application requires a higher input undervoltage lockout (UVLO) threshold, use the circuit shown in [Figure 18](#) to adjust the input voltage UVLO with two external resistors. When the EN pin voltage exceeds 1.24 V, an additional 3.5 μA of hysteresis current, I<sub>hys</sub>, is sourced out of the EN pin. When the EN pin is pulled below 1.14 V, the 3.5-μA I<sub>hys</sub> current is removed. This additional current facilitates adjustable input voltage hysteresis. Use [Equation 2](#) to calculate R<sub>UVLO1</sub> for the desired input start and stop voltages. Use [Equation 3](#) to similarly calculate R<sub>UVLO2</sub>.

In applications designed to start at relatively low input voltages (for example, from 4.7 V to 10 V) and withstand high input voltages (for example, from 40 V to 60 V), the EN pin may experience a voltage greater than the absolute maximum voltage of 8 V during the high input voltage condition. TI recommends using a zener diode to clamp the pin voltage below the absolute maximum rating.

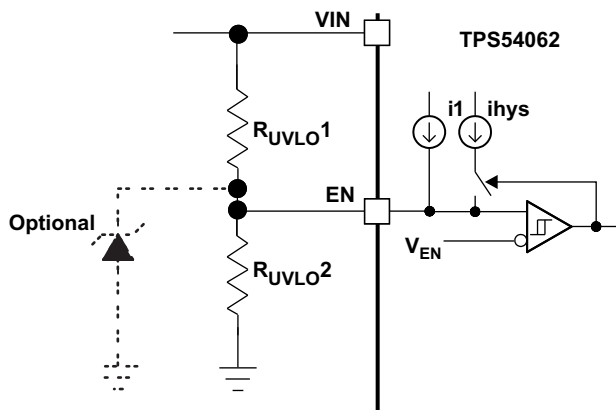

Copyright © 2016, Texas Instruments Incorporated

**Figure 18. Adjustable Undervoltage Lock Out**

## Feature Description (continued)

$$R_{UVLO1} = \frac{V_{START} \left( \frac{V_{ENAFALLING}}{V_{ENARISING}} \right) - V_{STOP}}{I_1 \times \left( 1 - \frac{V_{ENAFALLING}}{V_{ENARISING}} \right) + I_{HYS}} \quad (2)$$

$$R_{UVLO2} = \frac{R_{UVLO1} \times V_{ENAFALLING}}{V_{STOP} - V_{ENAFALLING} + R_{UVLO1} \times (I_1 + I_{HYS})} \quad (3)$$

### 7.3.7 Constant Switching Frequency and Timing Resistor (RT/CLK Pin)

The switching frequency of the TPS54062 is adjustable over a wide range from approximately 100 kHz to 400 kHz by placing a resistor on the RT/CLK pin. The RT/CLK pin voltage is typically 0.53 V and must have a resistor-to-ground to set the switching frequency. To determine the timing resistance for a given switching frequency, use Equation 4. To reduce the solution size, one would typically set the switching frequency as high as possible, but tradeoffs of the supply efficiency, maximum input voltage and minimum controllable on time should be considered. The minimum controllable on time is typically 130 ns and limits the maximum operating input voltage. The maximum switching frequency is also limited by the frequency shift circuit. More discussion on the details of the maximum switching frequency is located below.

$$R_T(k\Omega) = \frac{116720}{f_{SW}(kHz)^{0.9967}} \quad (4)$$

### 7.3.8 Selecting the Switching Frequency

The TPS54062 implements current mode control which uses the COMP pin voltage to turn off the high-side MOSFET on a cycle-by-cycle basis. Each cycle the switch current and COMP pin voltage are compared, when the peak switch current intersects the COMP voltage, the high-side switch is turned off. During overcurrent conditions that pull the output voltage low, the error amplifier will respond by driving the COMP pin high, increasing the switch current. The error amplifier output is clamped internally, which functions as a switch current limit.

To increase the maximum operating switching frequency at high input voltages the TPS54062 implements a frequency shift. The switching frequency is divided by 8, 4, 2, and 1 as the voltage ramps from 0 to 0.8 volts on VSENSE pin. The device implements a digital frequency shift to enable synchronizing to an external clock during normal start-up and fault conditions. Since the device can only divide the switching frequency by 8, there is a maximum input voltage limit in which the device operates and still have frequency shift protection. During short-circuit events (particularly with high input voltage applications), the control loop has a finite minimum controllable on time and the output has a low voltage. During the switch on-time, the inductor current ramps to the peak current limit because of the high input voltage and minimum on time. During the switch off-time, the inductor would normally not have enough off-time and output voltage for the inductor to ramp down by the ramp up amount. The frequency shift effectively increases the off time allowing the current to ramp down.

$$f_{SW}(\text{maxskip}) = \left( \frac{1}{t_{ON}} \right) \times \left( \frac{V_{OUT} + R_{LS} \times I_O + R_{DC} \times I_O}{V_{IN} - I_O \times R_{HS} + I_O \times R_{LS}} \right) \quad (5)$$

$$f_{SW}(\text{shift}) = \left( \frac{f_{div}}{t_{ON}} \right) \times \left( \frac{V_{OUTSC} + R_{LS} \times I_{CL} + R_{DC} \times I_{CL}}{V_{IN} - I_{CL} \times R_{HS} + I_{CL} \times R_{LS}} \right) \quad (6)$$

Where:

$I_O$  = Output current

$I_{CL}$  = Current Limit

$V_{IN}$  = Input Voltage

$V_{OUT}$  = Output Voltage

$V_{OUTSC}$  Output Voltage during short

$R_{DC}$  = Inductor resistance

$R_{HS}$  = High-side MOSFET resistance

$R_{LS}$  = Low-side MOSFET resistance

## Feature Description (continued)

$t_{on}$  = Controllable on-time

fdiv = Frequency divide (equals 1, 2, 4, or 8)

### 7.3.9 How to Interface to RT/CLK Pin

The RT/CLK pin can be used to synchronize the regulator to an external system clock. To implement the synchronization feature connect a square wave to the RT/CLK pin through one of the circuit networks shown in Figure 19. The square wave amplitude must transition lower than 0.5 V and higher than 1.3 V on the RT/CLK pin and have an on-time greater than 40 ns and an off-time greater than 40 ns. The synchronization frequency range is 300 kHz to 400 kHz. The rising edge of the PH will be synchronized to the falling edge of RT/CLK pin signal. The external synchronization circuit should be designed in such a way that the device will have the default frequency set resistor connected from the RT/CLK pin-to-ground should the synchronization signal turn off. TI recommends using a frequency set resistor connected as shown in Figure 19 through another resistor-to-ground (for example, 50  $\Omega$ ) for clock signal that are not Hi-Z or 3-state during the off-state. The sum of the resistance should set the switching frequency close to the external CLK frequency. TI recommends to AC couple the synchronization signal through a 10-pF ceramic capacitor to RT/CLK pin. The first time the CLK is pulled above the CLK threshold, the device switches from the RT resistor frequency to PLL mode. The internal 0.5-V voltage source is removed and the CLK pin becomes high impedance as the PLL starts to lock onto the external signal. Because there is a PLL on the regulator, the switching frequency can be higher or lower than the frequency set with the external resistor. The device transitions from the resistor mode to the PLL mode and then will increase or decrease the switching frequency until the PLL locks onto the CLK frequency within 100 microseconds. When the device transitions from the PLL to resistor mode the switching frequency will slow down from the CLK frequency to 150 kHz, then reapply the 0.5-V voltage and the resistor will then set the switching frequency. The switching frequency is divided by 8, 4, 2, and 1 as the voltage ramps from 0 to 0.8 volts on VSENSE pin. The device implements a digital frequency shift to enable synchronizing to an external clock during normal start-up and fault conditions.

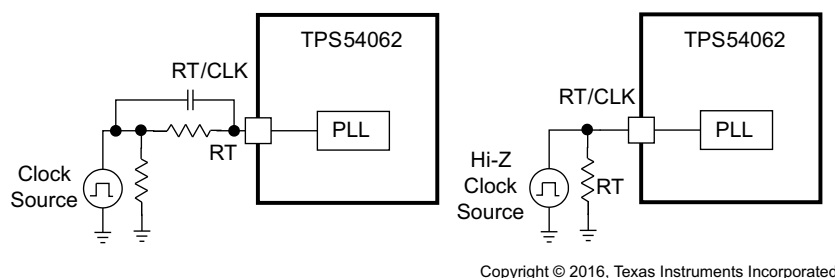

Figure 19. Synchronizing to a System Clock

### 7.3.10 Overvoltage Transient Protection

The TPS54062 incorporates an overvoltage transient protection (OVTP) circuit to minimize voltage overshoot when recovering from output fault conditions or strong unload transients on power supply designs with low-value output capacitance. For example, when the power supply output is overloaded the error amplifier compares the actual output voltage to the internal reference voltage. If the VSENSE pin voltage is lower than the internal reference voltage for a considerable time, the output of the error amplifier will respond by clamping the error amplifier output to a high voltage. Thus, requesting the maximum output current. Once the condition is removed, the regulator output rises and the error amplifier output transitions to the steady-state duty cycle. In some applications, the power supply output voltage can respond faster than the error amplifier output can respond, this actuality leads to the possibility of an output overshoot.

The OVTP feature minimizes the output overshoot, when using a low-value output capacitor, by implementing a circuit to compare the VSENSE pin voltage to OVTP threshold which is 109% of the internal voltage reference. If the VSENSE pin voltage is greater than the OVTP threshold, the high-side MOSFET is disabled preventing current from flowing to the output and minimizing output overshoot. When the VSENSE voltage drops lower than the OVTP threshold, the high-side MOSFET is allowed to turn on at the next clock cycle.

## Feature Description (continued)

### 7.3.11 Thermal Shutdown

The device implements an internal thermal shutdown to protect itself if the junction temperature exceeds 146°C. The thermal shutdown forces the device to stop switching when the junction temperature exceeds the thermal trip threshold. Once the die temperature decreases below 146°C, the device reinitiates the power-up sequence by restarting the internal slow-start.

## 7.4 Device Functional Modes

### 7.4.1 Operation Near Minimum Input Voltage

The TPS54062 is recommended to operate with input voltages above 4.7 V. The typical VIN UVLO threshold is 4.53 V and the device may operate at input voltages down to the UVLO voltage. At input voltages below the actual UVLO voltage, the device will not switch. If EN is floating or externally pulled up to greater up than the typical 1.24-V rising threshold, when  $V_{(VIN)}$  passes the UVLO threshold the TPS54062 will become active. Switching is enabled and the slow-start sequence is initiated. The TPS54062 starts linearly ramping up the internal reference DAC from 0 V to the reference voltage over the internal slow-start time period set by the switching frequency.

### 7.4.2 Operation With Enable Control

The enable start threshold voltage is 1.24 V typical. With EN held below the 1.24-V typical rising threshold voltage the TPS54062 is disabled and switching is inhibited even if VIN is above its UVLO threshold. The quiescent current is reduced in this state. If the EN voltage is increased above the rising threshold voltage while  $V_{(VIN)}$  is above the UVLO threshold, the device becomes active. Switching is enabled and the slow-start sequence is initiated. The TPS54062 starts linearly ramping up the internal reference DAC from 0 V to the reference voltage over the internal slow-start time period set by the switching frequency. If EN is pulled below the 1.14-V typical falling threshold the TPS54062 will enter the reduced quiescent current state again.



## 8 Applications and Implementation

### NOTE

Information in the following applications sections is not part of the TI component specification, and TI does not warrant its accuracy or completeness. TI's customers are responsible for determining suitability of components for their purposes. Customers should validate and test their design implementation to confirm system functionality.

### 8.1 Application Information

The TPS54062 is a 60-V, 50-mA step-down regulator with an integrated high-side and low-side MOSFET. This device is typically used to convert a higher DC voltage to a lower DC voltage with a maximum available output current of 50 mA. Example applications are: Low Power Standby or Bias Voltage Supplies, 4-20 mA Current-Loop Powered Sensors, Industrial Process Control, Metering, and Security Systems or an efficient high voltage linear regulator replacement. Use the following design procedure to select component values for the TPS54062. This procedure illustrates the design of a high frequency switching regulator. These calculations can be done with the aid of the excel spreadsheet tool [SLVC364](#). Alternatively, use the WEBENCH software to generate a complete design. The WEBENCH software uses an iterative design procedure and accesses a comprehensive database of components when generating a design.

### 8.2 Typical Applications

#### 8.2.1 Continuous Conduction Mode (CCM) Switching Regulator

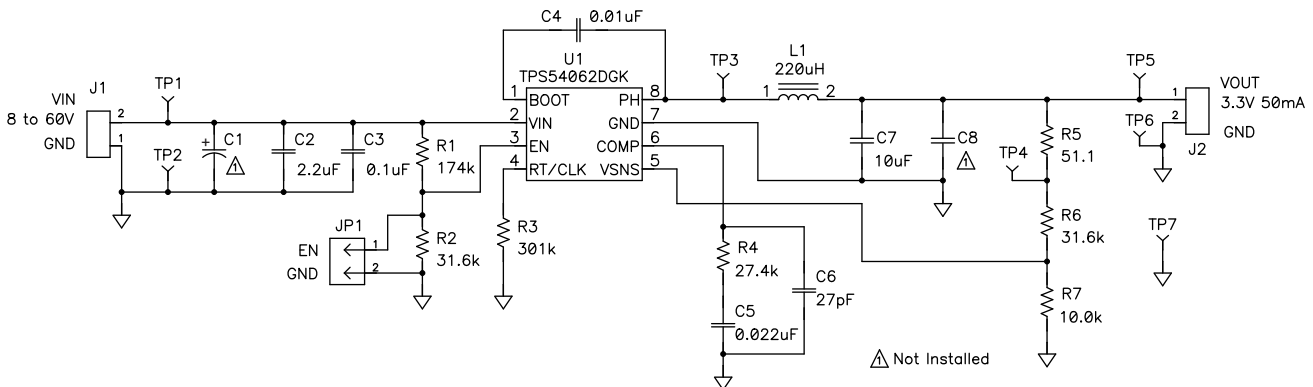

Copyright © 2016, Texas Instruments Incorporated

**Figure 20. Application Schematic**

#### 8.2.1.1 Design Requirements

This example details the design of a continuous conduction mode (CCM) switching regulator design using ceramic output capacitors. If a low-output current design is needed, see [DCM Application](#). A few parameters must be known in order to start the design process. These parameters are typically determined at the system level. For this example, we will start with the following known parameters:

Output Voltage	3.3 V
Transient Response 0 to 50-mA load step	$\Delta V_{OUT} = 4\%$
Maximum Output Current	50 mA
Input Voltage	24 V nom. 8 V to 60 V
Output Voltage Ripple	0.5% of $V_{OUT}$
Start Input Voltage (rising VIN)	7.88 V
Stop Input Voltage (falling VIN)	6.66 V

## Typical Applications (continued)

### 8.2.1.2 Detailed Design Procedure

#### 8.2.1.2.1 Selecting the Switching Frequency

The first step is to decide on a switching frequency for the regulator. Typically, the user will want to choose the highest switching frequency possible since this will produce the smallest solution size. The high-switching frequency allows for lower valued inductors and smaller output capacitors compared to a power supply that switches at a lower frequency. The switching frequency that can be selected is limited by the minimum on-time of the internal power switch, the input voltage and the output voltage and the frequency shift limitation.

Equation 5 and Equation 6 must be used to find the maximum switching frequency for the regulator, choose the lower value of the two equations. Switching frequencies higher than these values will result in pulse-skipping or the lack of overcurrent protection during a short circuit. The typical minimum on time,  $t_{on,min}$ , is 130 ns for the TPS54062. For this example, the output voltage is 3.3 V and the maximum input voltage is 60 V, which allows for a maximum switch frequency up to 400 kHz when including the inductor resistance, on resistance and diode voltage in Equation 5 or Equation 6. To ensure overcurrent runaway is not a concern during short circuits in your design use Equation 6 to determine the maximum switching frequency. With a maximum input voltage of 60 V, inductor resistance of 3.7  $\Omega$ , high-side switch resistance of 2.3  $\Omega$ , low-side switch resistance of 1.1  $\Omega$ , a current limit value of 120 mA and a short circuit output voltage of 0.1 V.

The maximum switching frequency is 400 kHz in both cases and a switching frequency of 400 kHz is used. To determine the timing resistance for a given switching frequency, use Equation 4. The switching frequency is set by resistor R3 shown in Figure 20. R3 is calculated to be 298 k $\Omega$ . A standard value of 301 k $\Omega$  is used.

#### 8.2.1.2.2 Output Inductor Selection (LO)

To calculate the minimum value of the output inductor, use Equation 7. KIND is a coefficient that represents the amount of inductor ripple current relative to the maximum output current. The inductor ripple current will be filtered by the output capacitor. Therefore, choosing high inductor ripple currents will impact the selection of the output capacitor since the output capacitor must have a ripple current rating equal to or greater than the inductor ripple current. In general, the inductor ripple value is at the discretion of the designer; however, the following guidelines may be used. Typically, TI recommends using KIND values in the range of 0.2 to 0.4; however, for designs using low-ESR output capacitors such as ceramics and low output currents, a value as high as KIND = 1 may be used. In a wide-input voltage regulator, it is best to choose an inductor ripple current on the larger side. This allows the inductor to still have a measurable ripple current with the input voltage at its minimum. For this design example, use KIND = 0.8 and the minimum inductor value is calculated to be 195  $\mu$ H. For this design, a near standard value was chosen: 220  $\mu$ H. For the output filter inductor, it is important that the RMS current and saturation current ratings not be exceeded. The RMS and peak inductor current can be found from Equation 9 and Equation 10.

For this design, the RMS inductor current is 50 mA and the peak inductor current is 68 mA. The chosen inductor is a Coilcraft LPS4018-224ML. It has a saturation current rating of 235 mA and an RMS current rating of 200 mA. As the equation set demonstrates, lower ripple currents will reduce the output voltage ripple of the regulator but will require a larger value of inductance. Selecting higher ripple currents will increase the output voltage ripple of the regulator but allow for a lower inductance value. The current flowing through the inductor is the inductor ripple current plus the output current. During power-up, faults or transient load conditions, the inductor current can increase above the calculated peak inductor current level calculated above. In transient conditions, the inductor current can increase up to the switch current limit of the device. For this reason, the most conservative approach is to specify an inductor with a saturation current rating equal to or greater than the switch current limit rather than the peak inductor current.

$$L_{Omin} \geq \left( \frac{V_{INmax} - V_{OUT}}{Kind \times I_o} \right) \times \frac{V_{OUT}}{V_{INmax} \times f_{SW}} \quad (7)$$

$$I_{RIPPLE} \geq \frac{V_{OUT} \times (V_{INmax} - V_{OUT})}{V_{INmax} \times L_O \times f_{SW}} \quad (8)$$

$$I_{Lrms} = \sqrt{I_o^2 + \frac{1}{12} \times \left( \frac{V_{OUT} \times (V_{INmax} - V_{OUT})}{V_{INmax} \times L_O \times f_{SW}} \right)^2} \quad (9)$$

## Typical Applications (continued)

$$I_{L\text{ peak}} = I_{\text{OUT}} + \frac{I_{\text{RIPPLE}}}{2} \quad (10)$$

### 8.2.1.2.3 Output Capacitor

There are three primary considerations for selecting the value of the output capacitor. The output capacitor will determine the modulator pole, the output voltage ripple, and how the regulator responds to a large change in load current. The output capacitance needs to be selected based on the more stringent of these three criteria. The desired response to a large change in the load current is the first criteria. The output capacitor needs to supply the load with current when the regulator can not. This situation would occur if there are desired hold-up times for the regulator where the output capacitor must hold the output voltage above a certain level for a specified amount of time after the input power is removed. The regulator also will temporarily not be able to supply sufficient output current if there is a large, fast increase in the current needs of the load such as transitioning from no load to a full load. The regulator usually needs two or more clock cycles for the control loop to see the change in load current and output voltage and adjust the duty cycle to react to the change. The output capacitor must be sized to supply the extra current to the load until the control loop responds to the load change. The output capacitance must be large enough to supply the difference in current for 2 clock cycles while only allowing a tolerable amount of droop in the output voltage. Equation 14 shows the minimum output capacitance necessary to accomplish this. Where  $\Delta I_{\text{OUT}}$  is the change in output current,  $f_{\text{SW}}$  is the regulators switching frequency and  $\Delta V_{\text{OUT}}$  is the allowable change in the output voltage.

For this example, the transient load response is specified as a 4% change in  $V_{\text{OUT}}$  for a load step from 0A (no load) to 50 mA (full load). For this example,  $\Delta I_{\text{OUT}} = 0.05 - 0 = 0.05$  and  $\Delta V_{\text{OUT}} = 0.04 \times 3.3 = 0.132$ .

Using these numbers gives a minimum capacitance of 1.89  $\mu\text{F}$ . This value does not take the ESR of the output capacitor into account in the output voltage change. For ceramic capacitors, the ESR is usually small enough to ignore in this calculation. Aluminum electrolytic and tantalum capacitors have higher ESR that should be taken into account. The low-side FET of the regulator emulates a diode so it can not sink current so any stored energy in the inductor will produce an output voltage overshoot when the load current rapidly decreases, see Figure 26. The output capacitor must also be sized to absorb energy stored in the inductor when transitioning from a high load current to a lower load current. The excess energy that gets stored in the output capacitor will increase the voltage on the capacitor. The capacitor must be sized to maintain the desired output voltage during these transient periods. Equation 13 is used to calculate the minimum capacitance to keep the output voltage overshoot to a desired value. Where  $L_{\text{O}}$  is the value of the inductor,  $I_{\text{OH}}$  is the output current under heavy load,  $I_{\text{OL}}$  is the output under light-load,  $V_{\text{F}}$  is the final peak output voltage, and  $V_{\text{i}}$  is the initial capacitor voltage. For this example, the worst case load step will be from 50 mA to 0A. The output voltage will increase during this load transition and the stated maximum in our specification is 4% of the output voltage. This will make  $V_{\text{F}} = 1.04 \times 3.3 = 3.432$  V.  $V_{\text{i}}$  is the initial capacitor voltage which is the nominal output voltage of 3.3 V. Using these numbers in Equation 14 yields a minimum capacitance of 0.619  $\mu\text{F}$ .

Equation 12 calculates the minimum output capacitance needed to meet the output voltage ripple specification. Where  $f_{\text{SW}}$  is the switching frequency,  $V_{\text{RIPPLE}}$  is the maximum allowable output voltage ripple, and  $I_{\text{RIPPLE}}$  is the inductor ripple current. Equation 13 yields 0.671  $\mu\text{F}$ . Equation 15 calculates the maximum ESR an output capacitor can have to meet the output voltage ripple specification. Equation 15 indicates the ESR should be less than 0.466  $\Omega$ .

The most stringent criteria for the output capacitor is 1.89  $\mu\text{F}$  of capacitance to keep the output voltage in regulation during an load transient.

Additional capacitance de-ratings for aging, temperature and DC bias should be factored in which will increase this minimum value. For this example, 10- $\mu\text{F}$ , 10V X5R ceramic capacitor with 0.003  $\Omega$  of ESR will be used. Capacitors generally have limits to the amount of ripple current they can handle without failing or producing excess heat. An output capacitor that can support the inductor ripple current must be specified. Some capacitor data sheets specify the Root Mean Square (RMS) value of the maximum ripple current.

Equation 11 can be used to calculate the RMS ripple current the output capacitor needs to support. For this application, Equation 11 yields 10.23 mA.

$$I_{\text{C}_{\text{O}}\text{rms}} = \frac{1}{\sqrt{12}} \times \left( \frac{V_{\text{OUT}} \times (V_{\text{INmax}} - V_{\text{OUT}})}{V_{\text{INmax}} \times L_{\text{O}} \times f_{\text{SW}}} \right) \quad (11)$$

## Typical Applications (continued)

$$C_{O1} \geq \frac{I_{\text{RIPPLE}}}{V_{\text{RIPPLE}}} \times \left( \frac{1}{8 \times f_{\text{SW}}} \right) \quad (12)$$

$$C_{O2} \geq L_O \times \frac{(I_{\text{OH}}^2 - I_{\text{OL}}^2)}{VF^2 - V_i^2} \quad (13)$$

$$C_{O3} \geq \frac{I_O}{\Delta V} \times \frac{2}{f_{\text{SW}}} \quad (14)$$

$$R_C \leq \frac{V_{\text{RIPPLE}}}{I_{\text{RIPPLE}}} \quad (15)$$

### 8.2.1.2.4 Input capacitor

The TPS54062 requires a high-quality ceramic, type X5R or X7R, input decoupling capacitor of at least 1 μF of effective capacitance and in some applications a bulk capacitance. The effective capacitance includes any DC bias effects. The voltage rating of the input capacitor must be greater than the maximum input voltage. The capacitor must also have a RMS current rating greater than the maximum RMS input current of the TPS54062. The input RMS current can be calculated using [Equation 16](#). The value of a ceramic capacitor varies significantly over temperature and the amount of DC bias applied to the capacitor. The capacitance variations due to temperature can be minimized by selecting a dielectric material that is stable over temperature. X5R and X7R ceramic dielectrics are usually selected for power regulator capacitors because they have a high capacitance to volume ratio and are fairly stable over temperature. The output capacitor must also be selected with the DC bias taken into account. The capacitance value of a capacitor decreases as the DC bias across a capacitor increases. For this example design, a ceramic capacitor with at least a 100-V voltage rating is required to support the maximum input voltage. The input capacitance value determines the input ripple voltage of the regulator. The input voltage ripple can be calculated using rearranging [Equation 17](#).

Using the design example values,  $I_{\text{outmax}} = 50 \text{ mA}$ ,  $C_{\text{IN}} = 2.2 \text{ μF}$ ,  $f_{\text{SW}} = 400 \text{ kHz}$ , yields an input voltage ripple of 14.2 mV and a RMS input ripple current of 24.6 mA.

$$I_{\text{CINrms}} = I_{\text{OUT}} \times \sqrt{\frac{V_{\text{OUT}}}{V_{\text{INmin}}} \times \frac{(V_{\text{INmin}} - V_{\text{OUT}})}{V_{\text{INMin}}}} \quad (16)$$

$$C_{\text{IN}} \geq \frac{I_O}{V_{\text{INripple}}} \times \left( \frac{0.25}{f_{\text{SW}}} \right) \quad (17)$$

### 8.2.1.2.5 Bootstrap Capacitor Selection

A 0.01-μF ceramic capacitor must be connected between the BOOT and PH pins for proper operation. TI recommends using a ceramic capacitor with X5R or better grade dielectric. The capacitor should have a 10-V or higher voltage rating.

### 8.2.1.2.6 Under Voltage Lock Out Set Point

The Under Voltage Lock Out (UVLO) can be adjusted using an external voltage divider on the EN pin of the TPS54062. The UVLO has two thresholds, one for power-up when the input voltage is rising and one for power-down or brownouts when the input voltage is falling. For the example design, the supply should turn on and start switching once the input voltage increases above 7.88 V (enabled). After the regulator starts switching, it should continue to do so until the input voltage falls below 6.66 V (UVLO stop). The programmable UVLO and enable voltages are set using a resistor divider between  $V_{\text{in}}$  and ground to the EN pin. [Equation 2](#) through [Equation 3](#) can be used to calculate the resistance values necessary. For the example application, a 174-kΩ resistor between  $V_{\text{in}}$  and EN and a 31.6-kΩ resistor between EN and ground are required to produce the 7.88 and 6.66 volt start and stop voltages.

### 8.2.1.2.7 Output Voltage and Feedback Resistors Selection

For the example design, 10-kΩ was selected for  $R_{\text{LS}}$ . Using [Equation 1](#),  $R_{\text{HS}}$  is calculated as 31.25 kΩ. The nearest standard 1% resistor is 31.6 kΩ.

## Typical Applications (continued)

### 8.2.1.2.8 Closing the Loop

There are several methods used to compensate DC - DC regulators. The method presented here is easy to calculate and ignores the effects of the slope compensation that is internal to the device. Since the slope compensation is ignored, the actual cross over frequency will usually be lower than the crossover frequency used in the calculations. This method assume the crossover frequency is between the modulator pole and the ESR zero and the ESR zero is at least 10 times greater the modulator pole. Use SwitcherPro™ software for a more accurate design.

To get started, the modulator pole,  $f_{pole}$ , and the ESR zero,  $f_{zero}$  must be calculated using [Equation 18](#) and [Equation 19](#). For  $C_{out}$ , use a derated value of 8.9  $\mu\text{F}$ . Use [Equation 20](#) and [Equation 21](#), to estimate a starting point for the crossover frequency,  $f_{co}$ , to design the compensation. For the example design,  $f_{pole}$  is 271 Hz and  $f_{zero}$  is 5960 kHz.

[Equation 20](#) is the geometric mean of the modulator pole and the ESR zero and [Equation 21](#) is the mean of modulator pole and the switching frequency. [Equation 20](#) yields 40.29 kHz and [Equation 21](#) gives 7.36 kHz. Use a frequency near the lower value of [Equation 20](#) or [Equation 21](#) for an initial crossover frequency.

For this example,  $f_{co}$  is 7.8 kHz. Next, the compensation components are calculated. A resistor in series with a capacitor is used to create a compensating zero. A capacitor in parallel to these two components forms the compensating pole.

To determine the compensation resistor,  $R_4$ , use [Equation 22](#). Assume the power stage transconductance,  $g_{mps}$ , is 0.65 A/V. The output voltage,  $V_o$ , reference voltage,  $V_{REF}$ , and amplifier transconductance,  $g_{mea}$ , are 3.3 V, 0.8 V and 102  $\mu\text{S}$ , respectively.

$R_4$  is calculated to be 27.1 k $\Omega$ , use the nearest standard value of 27.4 k $\Omega$ . Use [Equation 23](#) to set the compensation zero to the modulator pole frequency. [Equation 23](#) yields 0.0214  $\mu\text{F}$  for compensating capacitor  $C_5$ , a 0.022  $\mu\text{F}$  is used on the board. Use the larger value of [Equation 24](#) and [Equation 25](#) to calculate the  $C_6$  value, to set the compensation pole. [Equation 25](#) yields 29 pF so the nearest standard of 27 pF is used.

$$f_{pole}(\text{Hz}) = \frac{1}{\frac{V_o}{I_o} \times C_o \times 2 \times \pi} \quad (18)$$

$$f_{zero}(\text{Hz}) = \frac{1}{R_c \times C_o \times 2 \times \pi} \quad (19)$$

$$f_{co1}(\text{Hz}) = (f_{zero} \times f_{pole})^{0.5} \quad (20)$$

$$f_{co2}(\text{Hz}) = \left( \frac{f_{sw}}{2} \times f_{pole} \right)^{0.5} \quad (21)$$

$$R_4 = \frac{2 \times \pi \times f_{co} \times C_o}{g_{mps}} \times \frac{V_o}{V_{REF} \times g_{mea}} \quad (22)$$

$$C_5 = \frac{1}{2 \times \pi \times R_4 \times f_{POLE}} \quad (23)$$

$$C_6 = \frac{R_c \times C_o}{R_4} \quad (24)$$

$$C_6 = \frac{1}{R_4 \times f_{sw} \times \pi} \quad (25)$$

Typical Applications (continued)

8.2.1.3 Application Curves

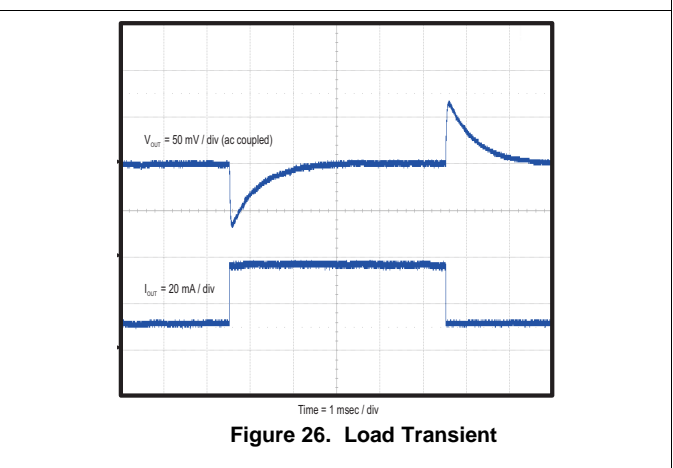
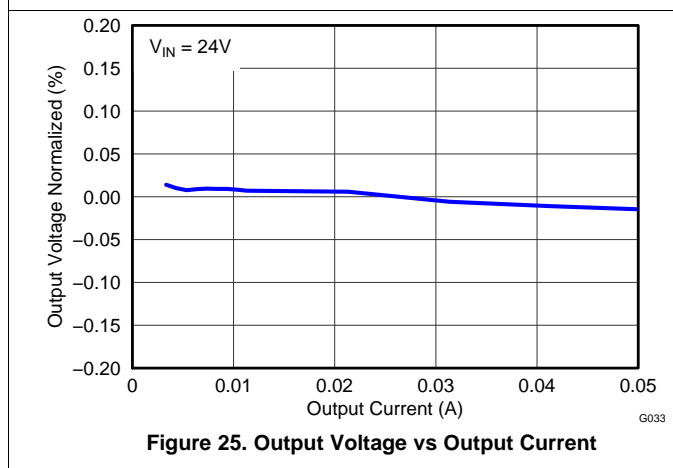
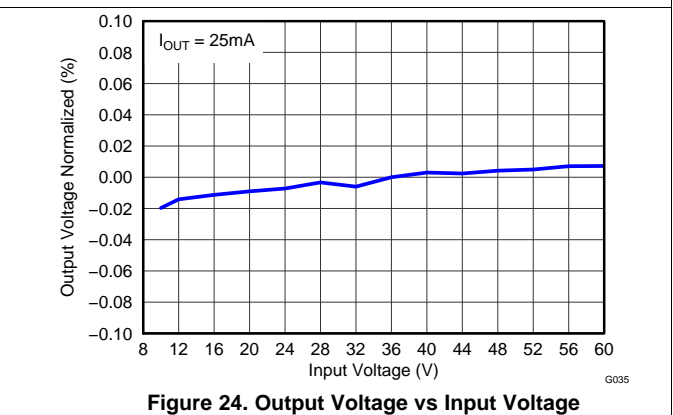
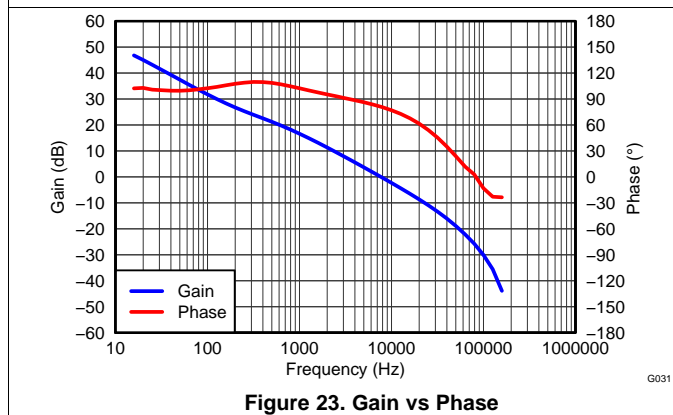
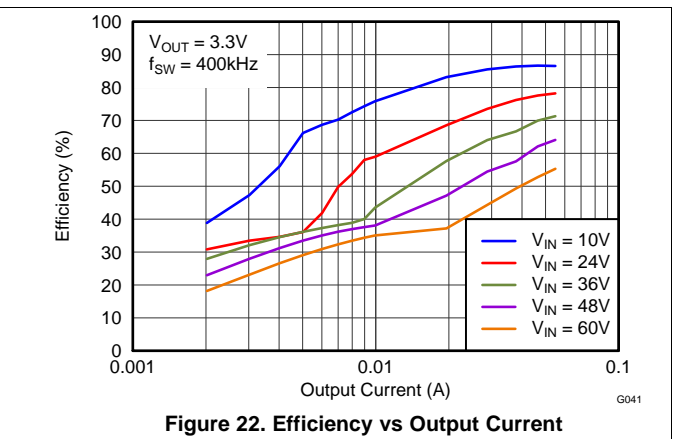
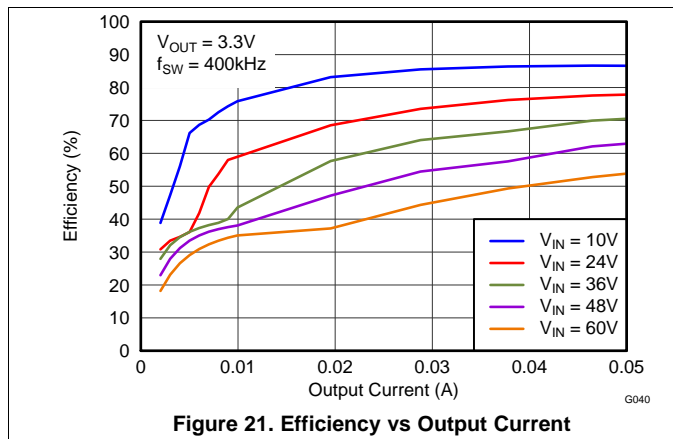

Typical Applications (continued)

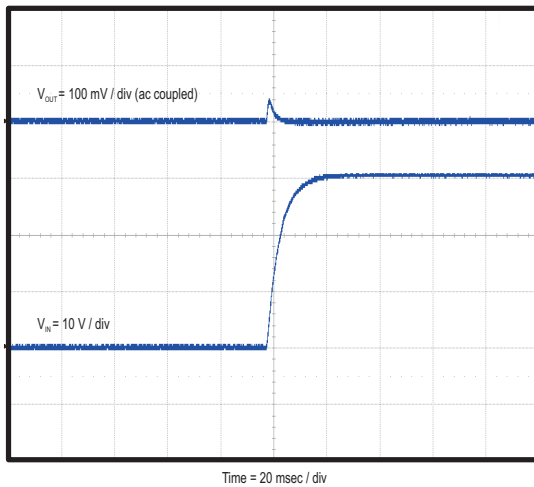

Figure 27. Line Transient

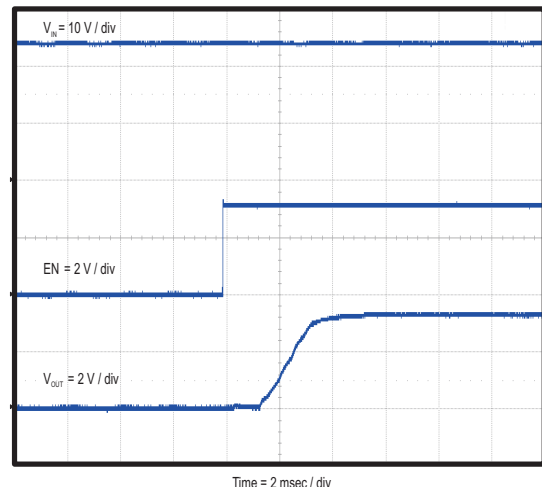

Figure 28. Start-Up With ENA

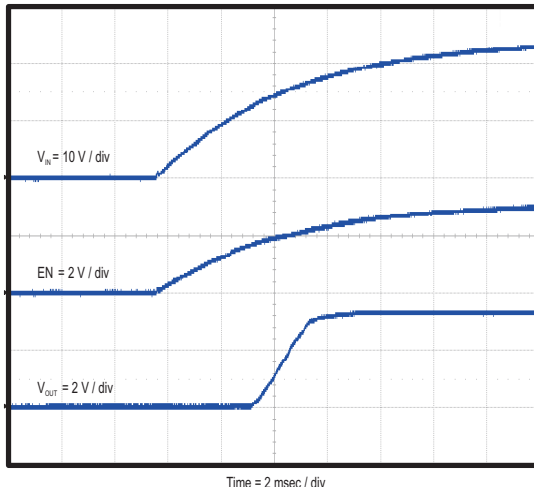

Figure 29. Start-Up With  $V_{IN}$

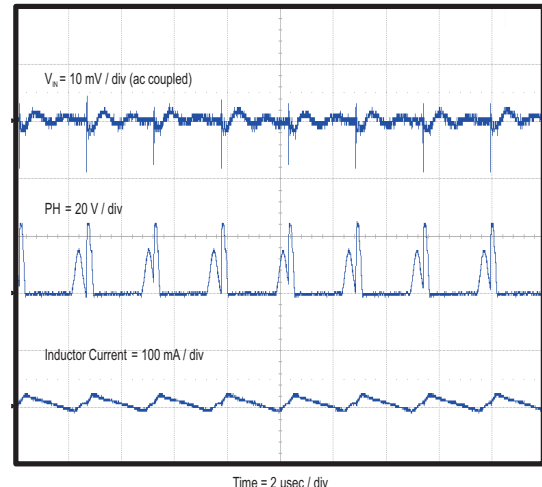

Figure 30. Input Ripple in DCM

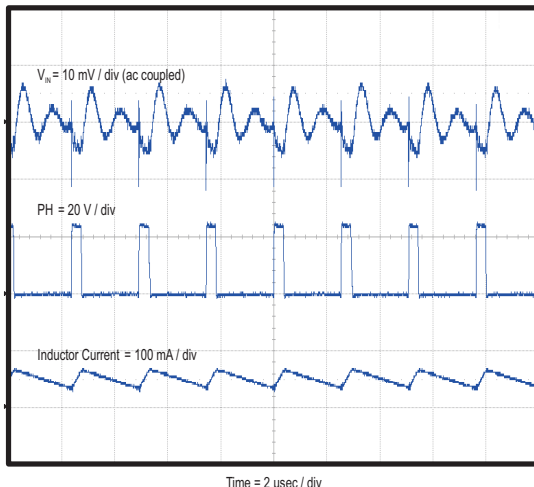

Figure 31. Input Ripple in CCM

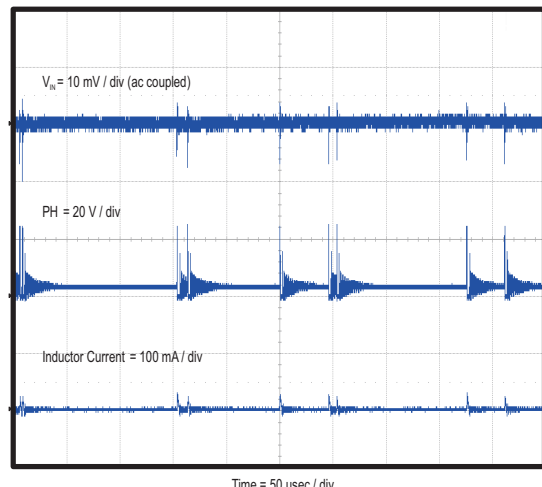
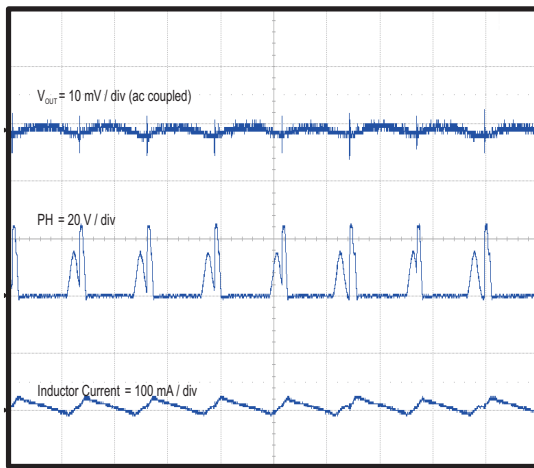
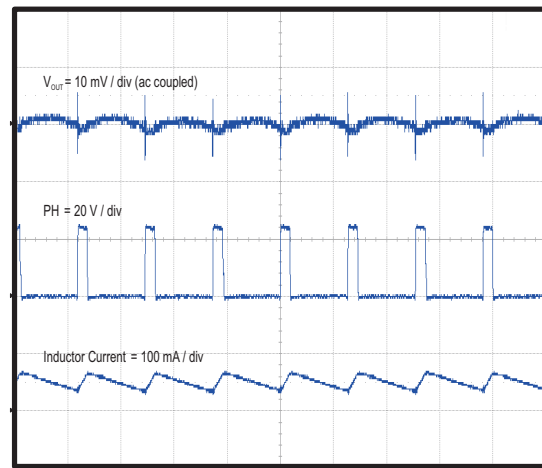

Figure 32. Input Ripple Skip

**Typical Applications (continued)**



**Figure 33. Output Ripple in DCM**



**Figure 34. Output Ripple in CCM**

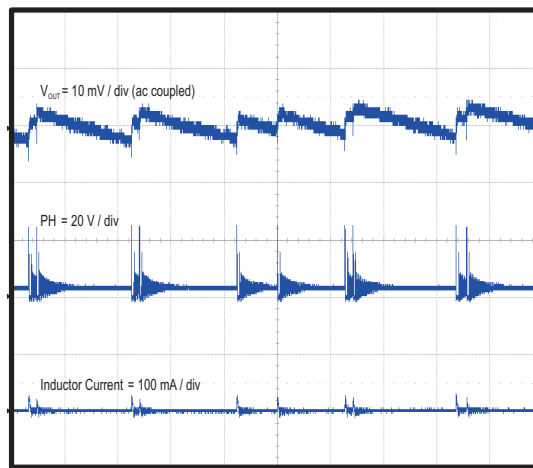
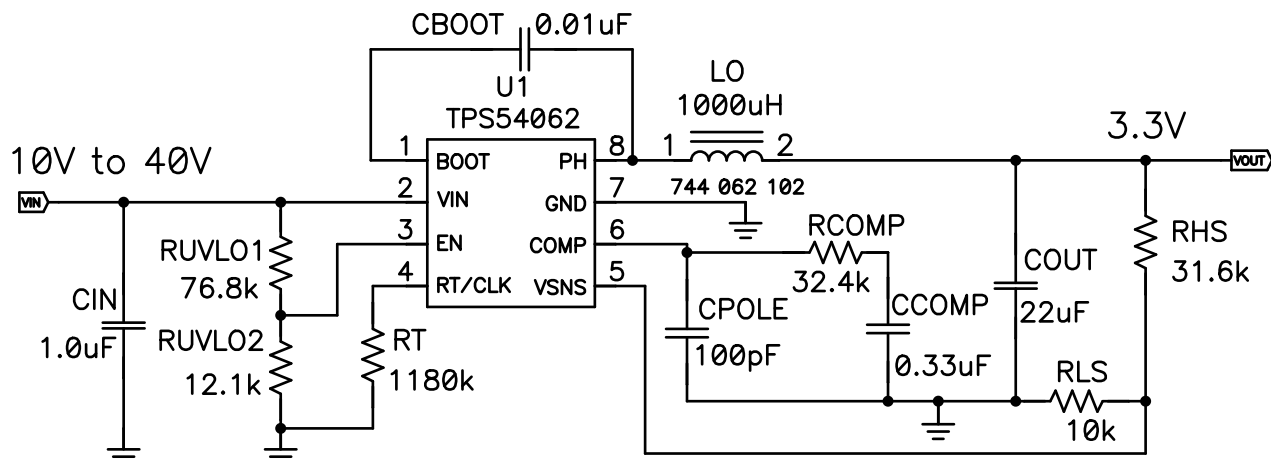

**Figure 35. Output Ripple Skip**



## Typical Applications (continued)

### 8.2.2 DCM Application



Copyright © 2016, Texas Instruments Incorporated

Figure 36. DCM Application Schematic

#### 8.2.2.1 Design Requirements

This example details the design of a low output current, fixed switching regulator design using ceramic output capacitors. A few parameters must be known in order to start the design process. These parameters are typically determined at the system level. For this example, we will start with the following known parameters:

Output Voltage	3.3 V
Transient Response 0 to 15 mA load-step	$\Delta V_{OUT} = 4\%$
Maximum Output Current	10 mA
Minimum Output Current	3 mA
Input Voltage	24 V nom. 10 V to 40 V
Output Voltage Ripple	0.5% of $V_{OUT}$
Switching Frequency	100 kHz
Start Input Voltage (rising VIN)	9 V
Stop Input Voltage (falling VIN)	8 V

#### 8.2.2.2 Detailed Design Procedure

It is most desirable to have a power supply that is efficient and has a fixed switching frequency at low output currents. A fixed frequency power supply will have a predictable output voltage ripple and noise. Using a traditional continuous conduction mode (CCM) design method to calculate the output inductor will yield a large inductance for a low output current supply. Using a CCM inductor will result in a large sized supply or will affect efficiency from the large DC resistance an alternative is to operate in discontinuous conduction mode (DCM). Use the procedure below to calculate the components values for designing a power supply operating in discontinuous conduction mode. The advantage of operating a power supply in DCM for low-output current is the fixed switching frequency, lower output inductance, and lower DC resistance on the inductor. Use the frequency shift and skip equations to estimate the maximum switching frequency.

The TPS54062 is designed for applications which require a fixed operating frequency and low-output voltage ripple at low output currents, thus, the TPS54062 does not have a pulse skip mode at light loads. Since the device has a minimum controllable on-time, there is an output current at which the power supply will pulse skip. To ensure that the supply does not pulse skip at output current of the application, the inductor value will be need to be selected greater than a minimum value. The minimum inductance needed to maintain a fixed switching

## Typical Applications (continued)

frequency at the minimum load is calculated to be 0.9 mH using Equation 26. Since the equation is ideal and was derived without losses, assume the minimum controllable light-load on-time,  $t_{onmin}$ , is 350 ns. To maintain DCM operation the inductor value and output current need to stay below a maximum value. The maximum inductance is calculated to be 1.42 mH using Equation 27. A 744062102 inductor from Würth Elektronik is selected. If CCM operation is necessary, use the previous design procedure.

Use Equation 28, to make sure the minimum current limit on the high-side power switch is not exceeded at the maximum output current. The peak current is calculated as 23.9 mA and is lower than the 134 mA current limit. To determine the RMS current for the inductor and output capacitor, it is necessary to calculate the duty cycle. The duty cycle, D1, for a step-down regulator in DCM is calculated in Equation 29. D1 is the portion of the switching cycle the high-side power switch is on, and is calculated to be 0.1153. D2 is the portion of the switching cycle the low-side power switch is on, and is calculated to be 0.7253.

Using the Equation 31 and Equation 32, the RMS current of the inductor and output capacitor are calculated, to be 12.8 mA and 7.6 mA respectively. Select components that ratings exceed the calculated RMS values. Calculate the output capacitance using the Equation 33 to Equation 35 and use the largest value,  $V_{RIPPLE}$  is the steady-state voltage ripple and  $\Delta V$  is voltage change during a transient. A minimum of 1.5- $\mu$ F capacitance is calculated. Additional capacitance de-ratings for aging, temperature and DC bias should be factored in which increases this minimum value. For this example, a 22- $\mu$ F, 6.3-V X7R ceramic capacitor with 5-m $\Omega$  ESR is used. To have a low output ripple power supply use a low-ESR capacitor. Use Equation 36 to estimate the maximum esr for the output capacitor. Equation 37 and Equation 38 estimate the RMS current and capacitance for the input capacitor. An RMS current of 3.7 mA and capacitance of 0.2  $\mu$ F is calculated. A 1- $\mu$ F 100V/X7R ceramic is used for this example.

$$L_{Omin} \geq \left( \frac{V_{Smax} - V_O}{V_O} \right) \times \left( \frac{V_{Smax}}{2} \right) \times \frac{t_{onmin}^2}{I_{Omin}} \times f_{SW} \quad (26)$$

$$L_{Omax} \leq \left( \frac{V_{Smin} - V_O}{2} \right) \times \left( \frac{V_O}{V_{Smin}} \right) \times \frac{1}{f_{SW} \times I_O} \quad (27)$$

$$I_{Lpeak} = \left( \frac{2 \times V_O \times I_{Omax} \times (V_{Smax} - V_O)}{V_{Smax} \times L_O \times f_{SW}} \right)^{0.5} \quad (28)$$

$$D1 = \left( \frac{2 \times V_O \times I_O \times L_O \times f_{SW}}{V_S \times (V_S - V_O)} \right)^{0.5} \quad (29)$$

$$D2 = \left( \frac{V_S - V_O}{V_O} \right) \times D1 \quad (30)$$

$$I_{Lrms} = I_{Lpeak} \times \left( \frac{D1 + D2}{3} \right)^{0.5} \quad (31)$$

$$I_{COrms} = I_{Lpeak} \times \left( \left( \frac{D1 + D2}{3} \right) - \left( \frac{D1 + D2}{4} \right)^2 \right)^{0.5} \quad (32)$$

$$C_{O1} \leq \frac{I_{Lpeak}}{V_{RIPPLE}} \times \left( \frac{D1 + D2}{8 \times f_{SW}} \right) \quad (33)$$

$$C_{O2} \geq L_O \times \frac{(I_O^2 - 0^2)}{(V_O + \Delta V)^2 - V_O^2} \quad (34)$$

$$C_{O3} \geq \frac{I_O}{\Delta V} \times \frac{1}{f_{CO}} \quad (35)$$

$$R_C \leq \frac{V_{RIPPLE}}{I_{Lpeak}} \quad (36)$$

## Typical Applications (continued)

$$I_{CIN,rms} = I_{L,peak} \times \left( \left( \frac{D1}{3} \right) - \left( \frac{D1}{4} \right)^2 \right)^{0.5} \quad (37)$$

$$C_{IN} \geq \frac{I_o}{V_{IN,RIPPLE}} \times \left( \frac{0.25}{f_{SW}} \right) \quad (38)$$

### 8.2.2.2.1 Closing the Feedback Loop

The method presented here is easy to calculate and includes the effect of the slope compensation that is internal to the device. This method assumes the crossover frequency is between the modulator pole and the ESR zero and the ESR zero is at least 10 times greater the modulator pole. Once the output components are determined, use the equations below to close the feedback loop. A current mode controlled power supply operating in DCM has a transfer function which has an ESR zero and pole as shown in Equation 39. To calculate the current mode power stage gain, first calculate,  $K_{dcm}$ , DCM gain, and  $F_m$ , modulator gain, in Equation 40 and Equation 41.  $K_{dcm}$  and  $F_m$  are 26.3 and 1.34 respectively. The location of the pole and ESR zero are calculated using Equation 42 and Equation 43. The pole and zero are 67 Hz and 2 MHz, respectively. Use the lower value of Equation 44 and Equation 45 as a starting point for the crossover frequency. Equation 44 is the geometric mean of the power stage pole and the ESR zero and Equation 45 is the mean of power stage pole and the switching frequency. The crossover frequency is chosen as 2.5 kHz from Equation 45.

To determine the compensation resistor,  $R_{COMP}$ , use Equation 46. Assume the power stage transconductance,  $g_{mps}$ , is 0.65 A/V. The output voltage,  $V_o$ , reference voltage,  $V_{REF}$ , and amplifier transconductance,  $g_{mea}$ , are 3.3 V, 0.8 V and 102  $\mu$ S, respectively.  $R_{COMP}$  is calculated to be 32.7 k $\Omega$ , use the nearest standard value of 32.4 k $\Omega$ . Use Equation 47 to set the compensation zero to the modulator pole frequency. Equation 47 yields 139 nF for compensating capacitor  $C_{COMP}$ , a 330 nF is used on the board. Use the larger value of Equation 48 or Equation 49 to calculate the  $C_{POLE}$ , to set the compensation pole. Equation 49 yields 98 pF so the nearest standard of 100 pF is used.

$$G_{dcm}(s) \approx F_m \times K_{dcm} \times \frac{1 + \frac{s}{2 \times \pi \times f_{ZERO}}}{1 + \frac{s}{2 \times \pi \times f_{POLE}}} \quad (39)$$

$$K_{dcm} = \frac{2}{D1} \times \frac{V_o \times (V_s - V_o)}{V_s \times \left( 2 + \frac{R_{dc}}{\frac{V_o}{I_o}} \right) - V_o} \quad (40)$$

$$F_m = \frac{g_{mps}}{\left( \frac{V_s - V_o}{L_o \times f_{SW}} \right) + 0.277} \quad (41)$$

$$f_{POLE}(Hz) = \frac{1}{\frac{V_o}{I_o} \times C_o \times 2 \times \pi} \times \left( \frac{2 - \frac{V_o}{V_s}}{1 - \frac{V_o}{V_s}} \right) \quad (42)$$

$$f_{ZERO}(Hz) = \frac{1}{R_c \times C_o \times 2 \times \pi} \quad (43)$$

$$f_{CO1}(Hz) = (f_{ZERO} \times f_{POLE})^{0.5} \quad (44)$$

$$f_{CO2}(Hz) = (f_{SW} \times f_{POLE})^{0.5} \quad (45)$$

Typical Applications (continued)

$$R_{COMP} = \frac{f_{CO}}{K_{dcm} \times F_m \times f_{POLE}} \times \frac{V_O}{V_{REF} \times g_{mea}} \tag{46}$$

$$C_{COMP} = \frac{1}{2 \times \pi \times R_{COMP} \times K_{dcm} \times F_m} \tag{47}$$

$$C_{POLE1} = \frac{R_C \times C_O}{R_{COMP}} \tag{48}$$

$$C_{POLE2} = \frac{1}{R_{COMP} \times f_{SW} \times \pi} \tag{49}$$

8.2.2.3 Application Curves

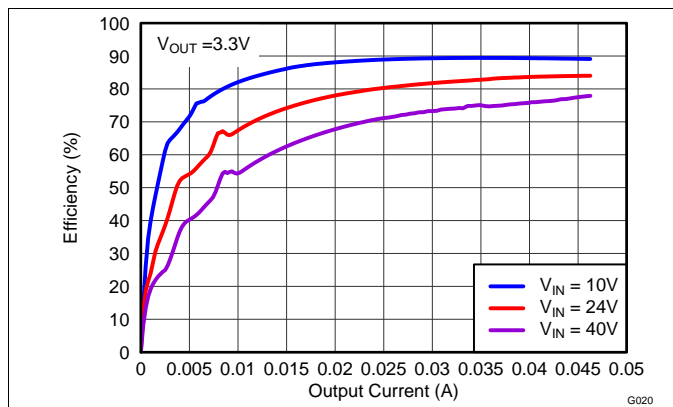

Figure 37. Efficiency vs Output Current

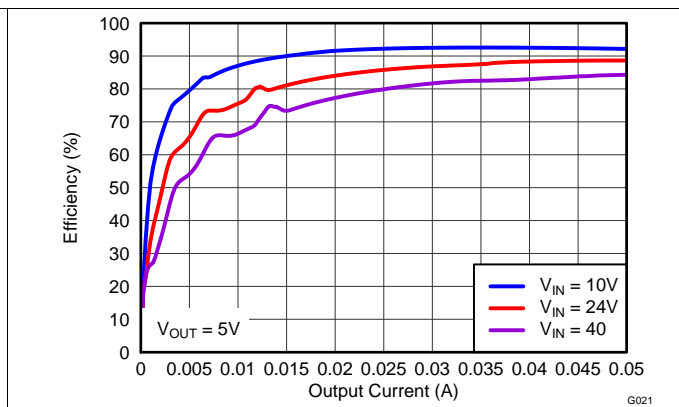

Figure 38. Efficiency vs Output Current

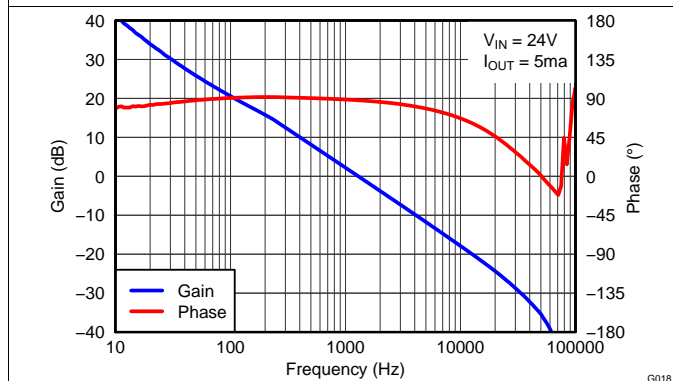

Figure 39. Gain vs Phase

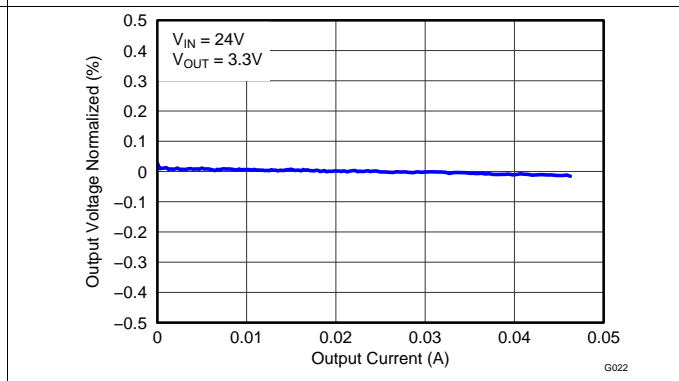
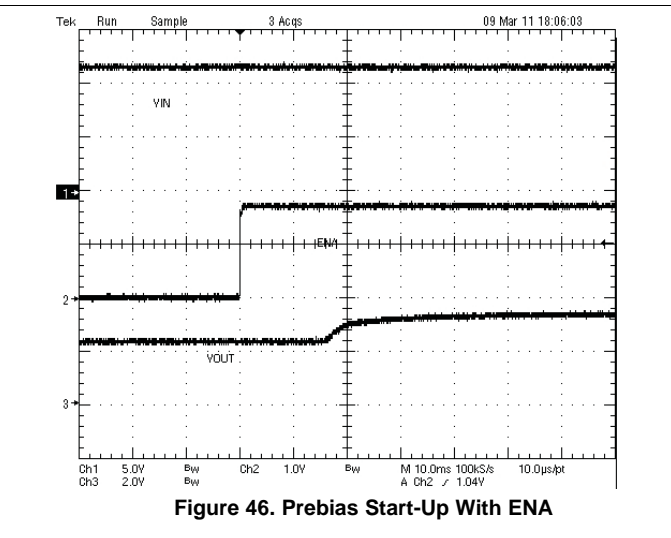
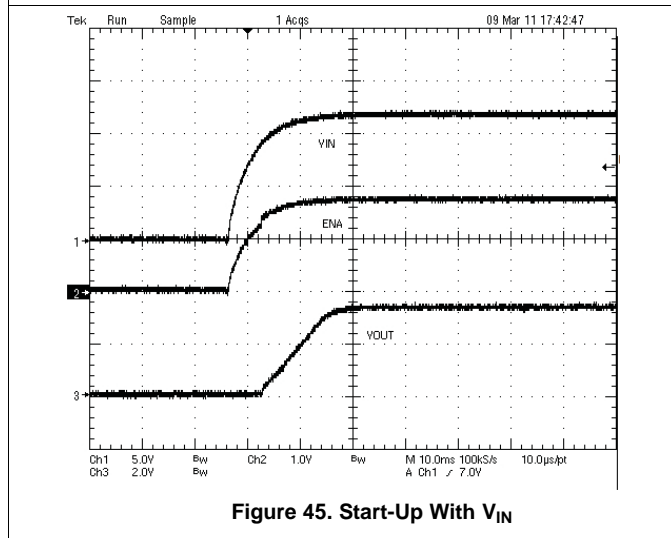
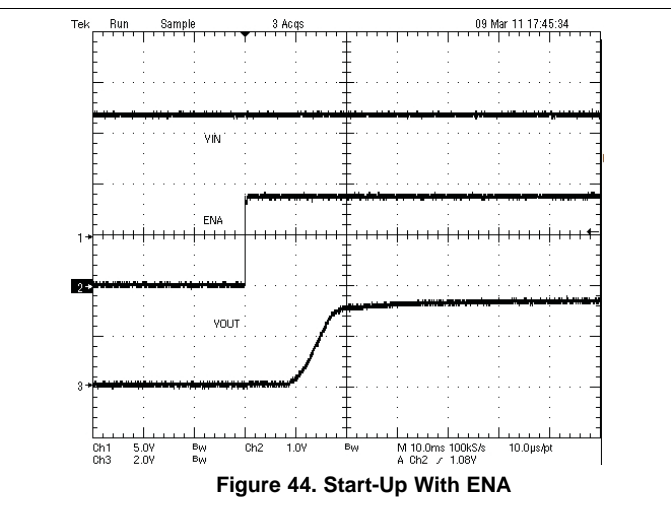
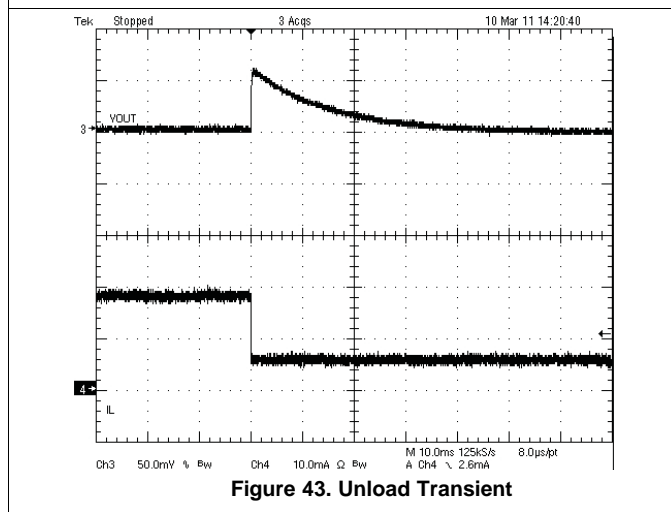
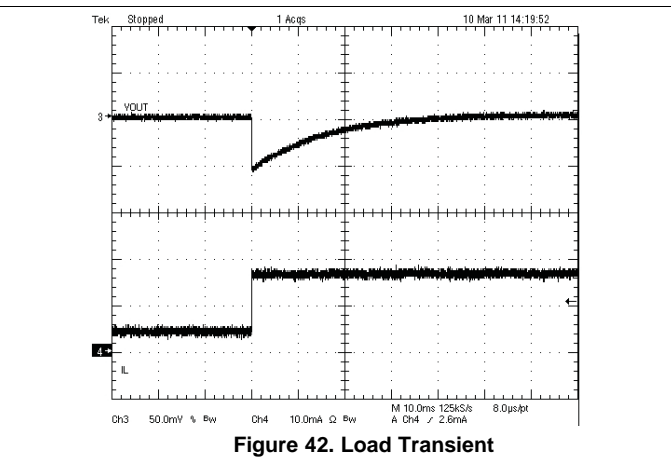
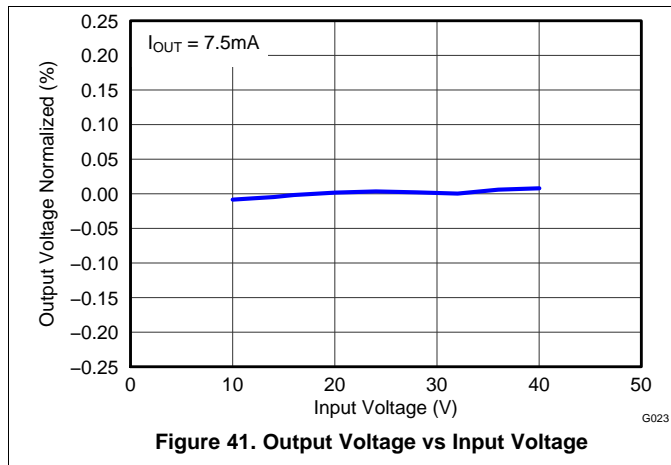
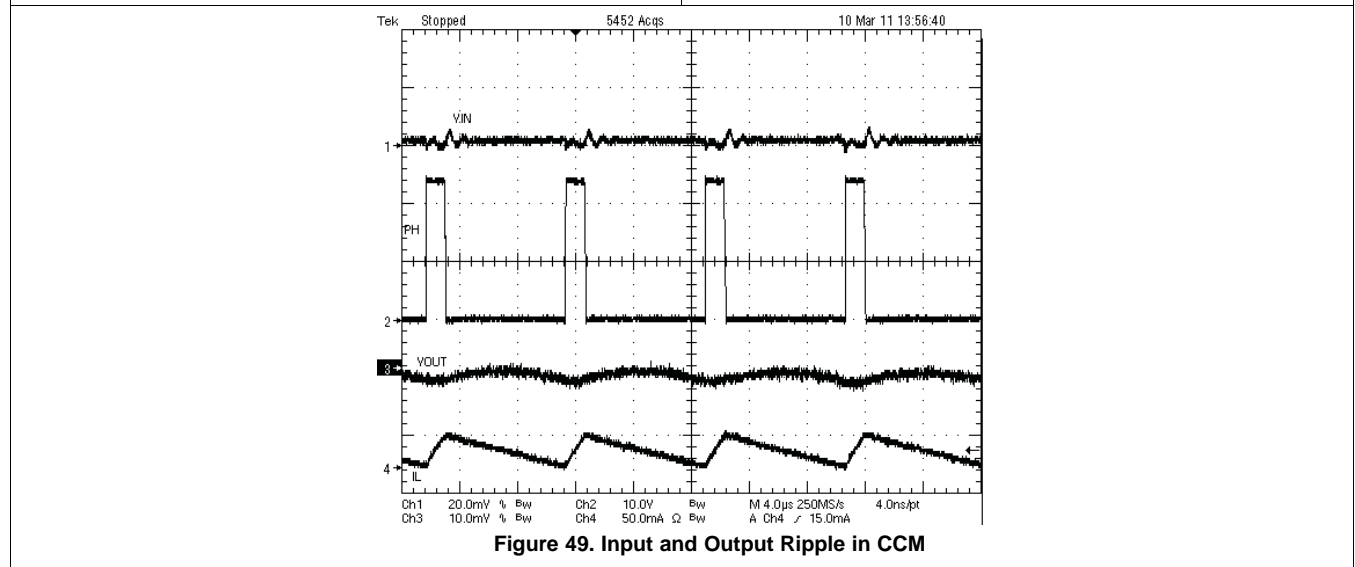
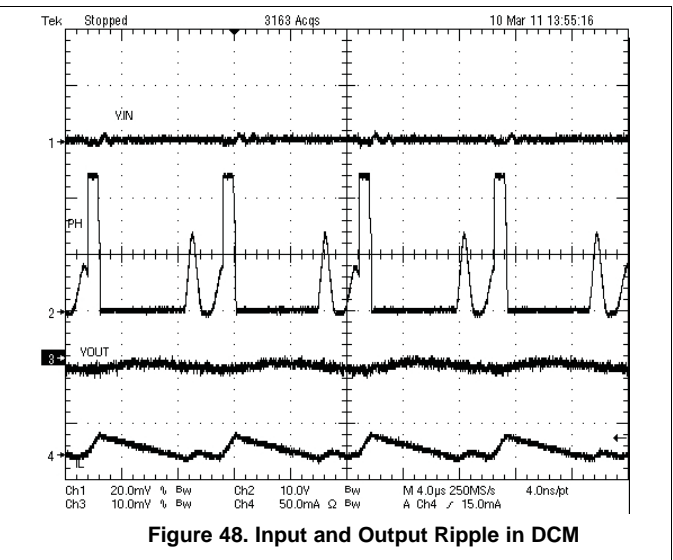
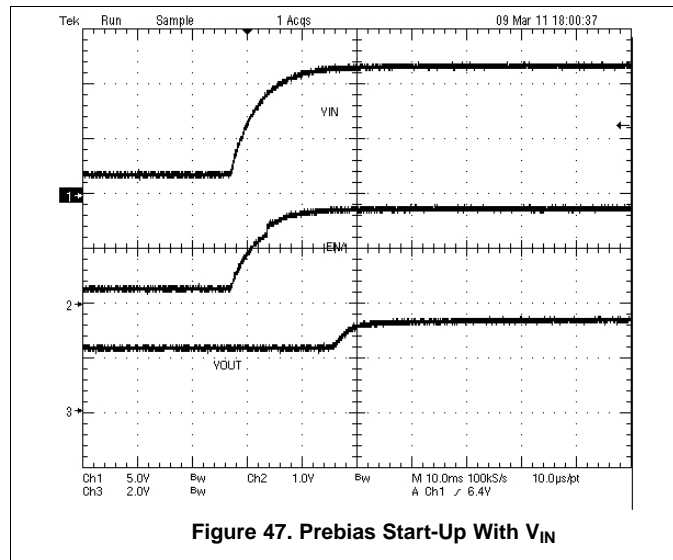

Figure 40. Output Voltage vs Output Current

Typical Applications (continued)



**Typical Applications (continued)**



## 9 Power Supply Recommendations

The TPS54062 is designed to operate from an input voltage supply range between 4.7 V and 60 V. This input supply should remain within the input voltage supply range. If the input supply is located more than a few inches from the TPS54062 converter bulk capacitance may be required in addition to the ceramic bypass capacitors.

## 10 Layout

### 10.1 Layout Guidelines

Layout is a critical portion of good power supply design. There are several signals paths that conduct fast changing currents or voltages that can interact with stray inductance or parasitic capacitance to generate noise or degrade the power supplies performance. To help eliminate these problems, the VIN pin should be bypassed to ground with a low-ESR ceramic bypass capacitor with X5R or X7R dielectric. Take care to minimize the loop area formed by the bypass capacitor connections, the VIN pin, and the GND pin. See Figure 50 for a PCB layout example. Since the PH connection is the switching node and output inductor should be located close to the PH pins, and the area of the PCB conductor minimized to prevent excessive capacitive coupling. The RT/CLK pin is sensitive to noise, so the RT resistor should be located as close as possible to the IC and routed with minimal lengths of trace. The additional external components can be placed approximately as shown. It may be possible to obtain acceptable performance with alternate PCB layouts; however; this layout has been shown to produce good results and is meant as a guideline.

All sensitive analog traces and components such as VSENSE, RT/CLK and COMP should be placed away from high-voltage switching nodes such as PH, BOOT and inductor to avoid coupling. The topside resistor of the feedback voltage divider should be connected to the positive node of the VOUT capacitors or after the VOUT capacitors.

### 10.2 Layout Example

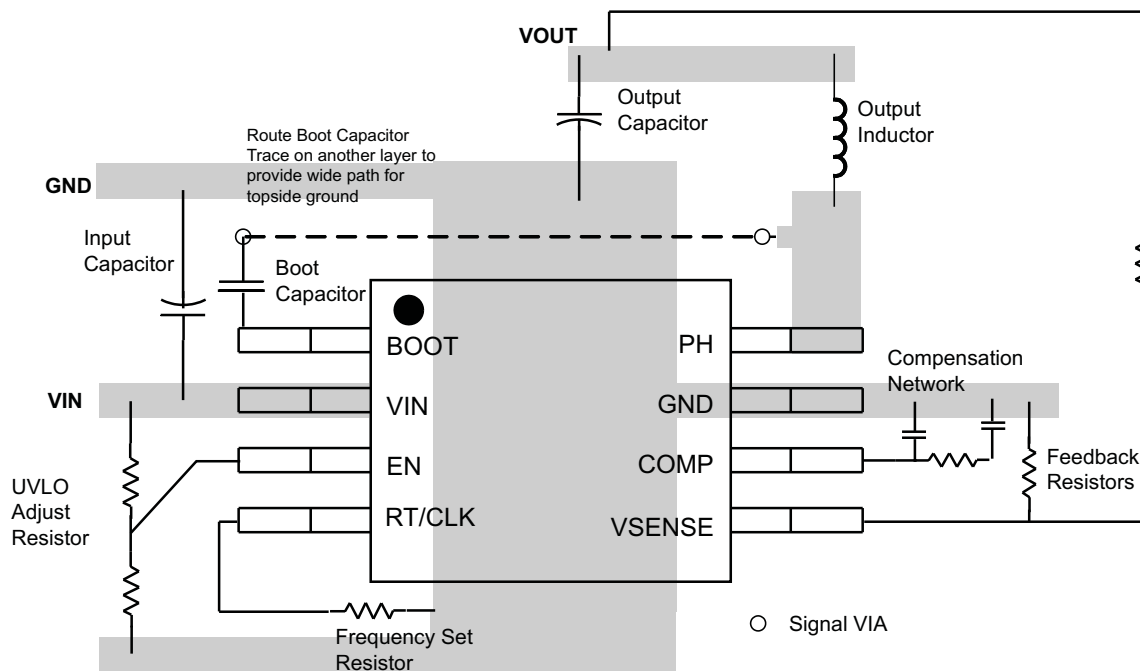

Figure 50. PCB Layout Example

## 11 Device and Documentation Support

### 11.1 Receiving Notification of Documentation Updates

To receive notification of documentation updates, navigate to the device product folder on ti.com. In the upper right corner, click on *Alert me* to register and receive a weekly digest of any product information that has changed. For change details, review the revision history included in any revised document.

### 11.2 Community Resources

The following links connect to TI community resources. Linked contents are provided "AS IS" by the respective contributors. They do not constitute TI specifications and do not necessarily reflect TI's views; see TI's [Terms of Use](#).

**TI E2E™ Online Community** *TI's Engineer-to-Engineer (E2E) Community*. Created to foster collaboration among engineers. At e2e.ti.com, you can ask questions, share knowledge, explore ideas and help solve problems with fellow engineers.

**Design Support** *TI's Design Support* Quickly find helpful E2E forums along with design support tools and contact information for technical support.

### 11.3 Trademarks

SwitcherPro, E2E are trademarks of Texas Instruments.  
All other trademarks are the property of their respective owners.

### 11.4 Electrostatic Discharge Caution



These devices have limited built-in ESD protection. The leads should be shorted together or the device placed in conductive foam during storage or handling to prevent electrostatic damage to the MOS gates.

### 11.5 Glossary

[SLYZ022](#) — *TI Glossary*.

This glossary lists and explains terms, acronyms, and definitions.

## 12 Mechanical, Packaging, and Orderable Information

The following pages include mechanical, packaging, and orderable information. This information is the most current data available for the designated devices. This data is subject to change without notice and revision of this document. For browser-based versions of this data sheet, refer to the left-hand navigation.



**PACKAGING INFORMATION**

Orderable Device	Status (1)	Package Type	Package Drawing	Pins	Package Qty	Eco Plan (2)	Lead finish/ Ball material (6)	MSL Peak Temp (3)	Op Temp (°C)	Device Marking (4/5)	Samples
TPS54062DGKR	ACTIVE	VSSOP	DGK	8	2500	RoHS & Green	NIPDAUAG	Level-2-260C-1 YEAR	-40 to 125	54062	<a href="#">Samples</a>
TPS54062DRBR	ACTIVE	SON	DRB	8	3000	RoHS & Green	NIPDAU	Level-2-260C-1 YEAR	-40 to 125	062	<a href="#">Samples</a>
TPS54062DRBT	ACTIVE	SON	DRB	8	250	RoHS & Green	NIPDAU	Level-2-260C-1 YEAR	-40 to 125	062	<a href="#">Samples</a>

(1) The marketing status values are defined as follows:

**ACTIVE:** Product device recommended for new designs.

**LIFEBUY:** TI has announced that the device will be discontinued, and a lifetime-buy period is in effect.

**NRND:** Not recommended for new designs. Device is in production to support existing customers, but TI does not recommend using this part in a new design.

**PREVIEW:** Device has been announced but is not in production. Samples may or may not be available.

**OBSOLETE:** TI has discontinued the production of the device.

(2) **RoHS:** TI defines "RoHS" to mean semiconductor products that are compliant with the current EU RoHS requirements for all 10 RoHS substances, including the requirement that RoHS substance do not exceed 0.1% by weight in homogeneous materials. Where designed to be soldered at high temperatures, "RoHS" products are suitable for use in specified lead-free processes. TI may reference these types of products as "Pb-Free".

**RoHS Exempt:** TI defines "RoHS Exempt" to mean products that contain lead but are compliant with EU RoHS pursuant to a specific EU RoHS exemption.

**Green:** TI defines "Green" to mean the content of Chlorine (Cl) and Bromine (Br) based flame retardants meet JS709B low halogen requirements of <=1000ppm threshold. Antimony trioxide based flame retardants must also meet the <=1000ppm threshold requirement.

(3) MSL, Peak Temp. - The Moisture Sensitivity Level rating according to the JEDEC industry standard classifications, and peak solder temperature.

(4) There may be additional marking, which relates to the logo, the lot trace code information, or the environmental category on the device.

(5) Multiple Device Markings will be inside parentheses. Only one Device Marking contained in parentheses and separated by a "~" will appear on a device. If a line is indented then it is a continuation of the previous line and the two combined represent the entire Device Marking for that device.

(6) Lead finish/Ball material - Orderable Devices may have multiple material finish options. Finish options are separated by a vertical ruled line. Lead finish/Ball material values may wrap to two lines if the finish value exceeds the maximum column width.

**Important Information and Disclaimer:**The information provided on this page represents TI's knowledge and belief as of the date that it is provided. TI bases its knowledge and belief on information provided by third parties, and makes no representation or warranty as to the accuracy of such information. Efforts are underway to better integrate information from third parties. TI has taken and continues to take reasonable steps to provide representative and accurate information but may not have conducted destructive testing or chemical analysis on incoming materials and chemicals. TI and TI suppliers consider certain information to be proprietary, and thus CAS numbers and other limited information may not be available for release.

In no event shall TI's liability arising out of such information exceed the total purchase price of the TI part(s) at issue in this document sold by TI to Customer on an annual basis.

## TAPE AND REEL INFORMATION



### QUADRANT ASSIGNMENTS FOR PIN 1 ORIENTATION IN TAPE



\*All dimensions are nominal

Device	Package Type	Package Drawing	Pins	SPQ	Reel Diameter (mm)	Reel Width W1 (mm)	A0 (mm)	B0 (mm)	K0 (mm)	P1 (mm)	W (mm)	Pin1 Quadrant
TPS54062DGKR	VSSOP	DGK	8	2500	330.0	12.4	5.3	3.3	1.3	8.0	12.0	Q1
TPS54062DRBR	SON	DRB	8	3000	330.0	12.4	3.3	3.3	1.1	8.0	12.0	Q2
TPS54062DRBT	SON	DRB	8	250	180.0	12.4	3.3	3.3	1.1	8.0	12.0	Q2

**TAPE AND REEL BOX DIMENSIONS**

\*All dimensions are nominal

Device	Package Type	Package Drawing	Pins	SPQ	Length (mm)	Width (mm)	Height (mm)
TPS54062DGKR	VSSOP	DGK	8	2500	367.0	367.0	38.0
TPS54062DRBR	SON	DRB	8	3000	367.0	367.0	35.0
TPS54062DRBT	SON	DRB	8	250	210.0	185.0	35.0

DGK (S-PDSO-G8)

PLASTIC SMALL-OUTLINE PACKAGE



- NOTES:
- A. All linear dimensions are in millimeters.
  - B. This drawing is subject to change without notice.
  - C. Body length does not include mold flash, protrusions, or gate burrs. Mold flash, protrusions, or gate burrs shall not exceed 0.15 per end.
  - D. Body width does not include interlead flash. Interlead flash shall not exceed 0.50 per side.
  - E. Falls within JEDEC MO-187 variation AA, except interlead flash.



- NOTES:
- A. All linear dimensions are in millimeters.
  - B. This drawing is subject to change without notice.
  - C. Publication IPC-7351 is recommended for alternate designs.
  - D. Laser cutting apertures with trapezoidal walls and also rounding corners will offer better paste release. Customers should contact their board assembly site for stencil design recommendations. Refer to IPC-7525 for other stencil recommendations.
  - E. Customers should contact their board fabrication site for solder mask tolerances between and around signal pads.

**DRB 8**

**GENERIC PACKAGE VIEW**

**VSON - 1 mm max height**

PLASTIC SMALL OUTLINE - NO LEAD



Images above are just a representation of the package family, actual package may vary.  
Refer to the product data sheet for package details.

4203482/L

DRB0008B



PACKAGE OUTLINE

VSON - 1 mm max height

PLASTIC SMALL OUTLINE - NO LEAD

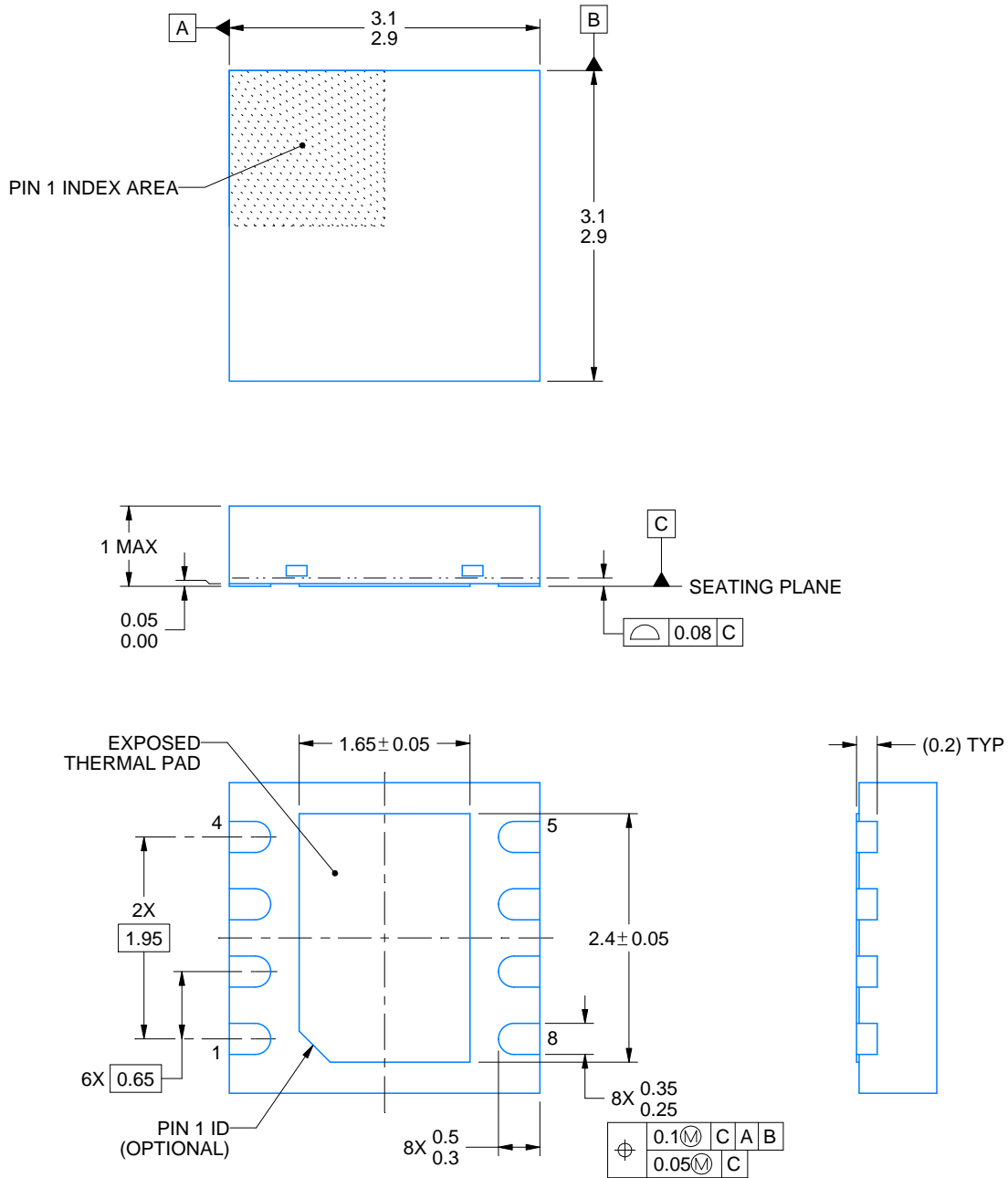

4218876/A 12/2017

NOTES:

1. All linear dimensions are in millimeters. Any dimensions in parenthesis are for reference only. Dimensioning and tolerancing per ASME Y14.5M.
2. This drawing is subject to change without notice.
3. The package thermal pad must be soldered to the printed circuit board for thermal and mechanical performance.



# EXAMPLE BOARD LAYOUT

**DRB0008B**

**VSON - 1 mm max height**

PLASTIC SMALL OUTLINE - NO LEAD

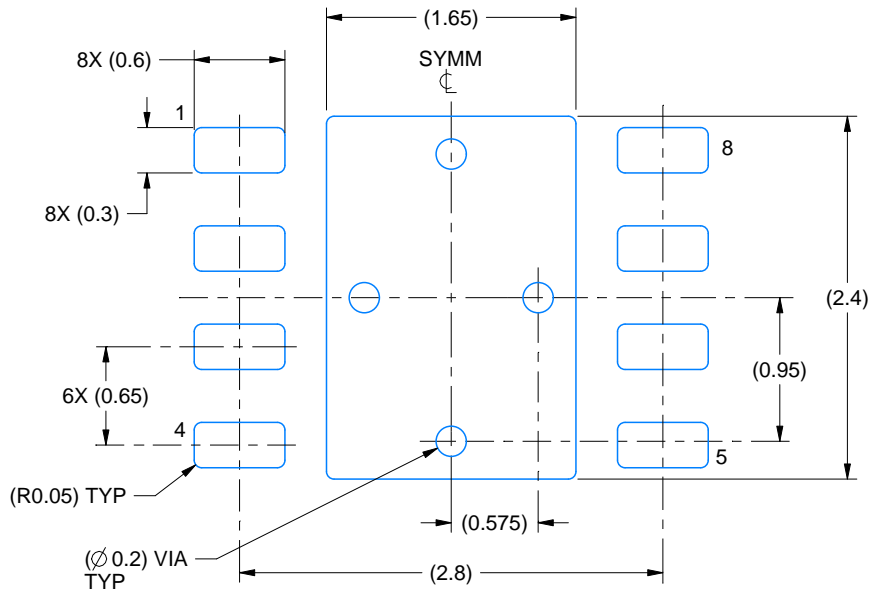

LAND PATTERN EXAMPLE  
SCALE:20X



SOLDER MASK DETAILS

4218876/A 12/2017

NOTES: (continued)

4. This package is designed to be soldered to a thermal pad on the board. For more information, see Texas Instruments literature number SLUA271 ([www.ti.com/lit/sluea271](http://www.ti.com/lit/sluea271)).
5. Vias are optional depending on application, refer to device data sheet. If any vias are implemented, refer to their locations shown on this view. It is recommended that vias under paste be filled, plugged or tented.

# EXAMPLE STENCIL DESIGN

DRB0008B

VSON - 1 mm max height

PLASTIC SMALL OUTLINE - NO LEAD



SOLDER PASTE EXAMPLE  
BASED ON 0.125 mm THICK STENCIL  
EXPOSED PAD  
81% PRINTED SOLDER COVERAGE BY AREA  
SCALE:25X

4218876/A 12/2017

NOTES: (continued)

6. Laser cutting apertures with trapezoidal walls and rounded corners may offer better paste release. IPC-7525 may have alternate design recommendations.

## IMPORTANT NOTICE AND DISCLAIMER

TI PROVIDES TECHNICAL AND RELIABILITY DATA (INCLUDING DATASHEETS), DESIGN RESOURCES (INCLUDING REFERENCE DESIGNS), APPLICATION OR OTHER DESIGN ADVICE, WEB TOOLS, SAFETY INFORMATION, AND OTHER RESOURCES "AS IS" AND WITH ALL FAULTS, AND DISCLAIMS ALL WARRANTIES, EXPRESS AND IMPLIED, INCLUDING WITHOUT LIMITATION ANY IMPLIED WARRANTIES OF MERCHANTABILITY, FITNESS FOR A PARTICULAR PURPOSE OR NON-INFRINGEMENT OF THIRD PARTY INTELLECTUAL PROPERTY RIGHTS.

These resources are intended for skilled developers designing with TI products. You are solely responsible for (1) selecting the appropriate TI products for your application, (2) designing, validating and testing your application, and (3) ensuring your application meets applicable standards, and any other safety, security, or other requirements. These resources are subject to change without notice. TI grants you permission to use these resources only for development of an application that uses the TI products described in the resource. Other reproduction and display of these resources is prohibited. No license is granted to any other TI intellectual property right or to any third party intellectual property right. TI disclaims responsibility for, and you will fully indemnify TI and its representatives against, any claims, damages, costs, losses, and liabilities arising out of your use of these resources.

TI's products are provided subject to TI's Terms of Sale (<https://www.ti.com/legal/termsofsale.html>) or other applicable terms available either on [ti.com](https://www.ti.com) or provided in conjunction with such TI products. TI's provision of these resources does not expand or otherwise alter TI's applicable warranties or warranty disclaimers for TI products.

Mailing Address: Texas Instruments, Post Office Box 655303, Dallas, Texas 75265  
Copyright © 2021, Texas Instruments Incorporated